

Serie 4000/21

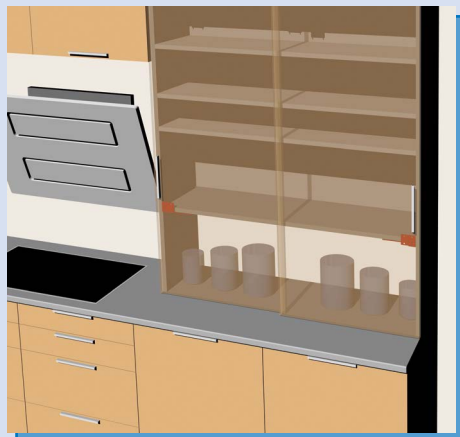

Sistema scorrevole ammortizzato
per ante pensili da cucina
Sliding system with shock absorber
for kitchen top cabinets

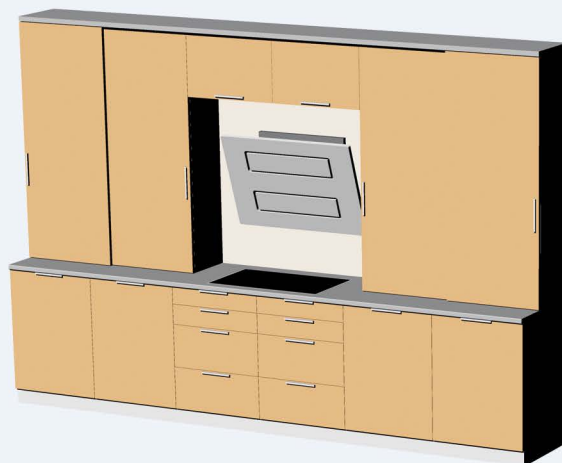

MADE IN ITALY
Villes 2000

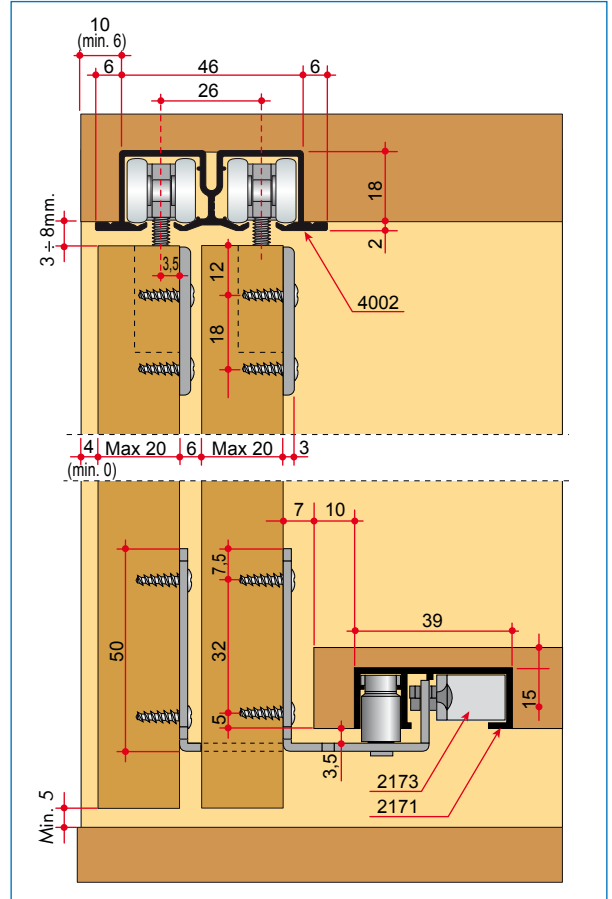
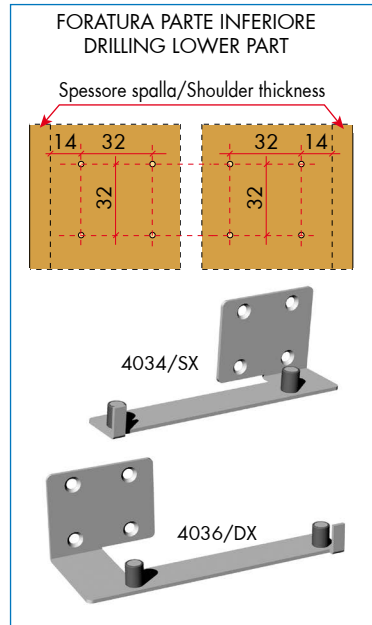
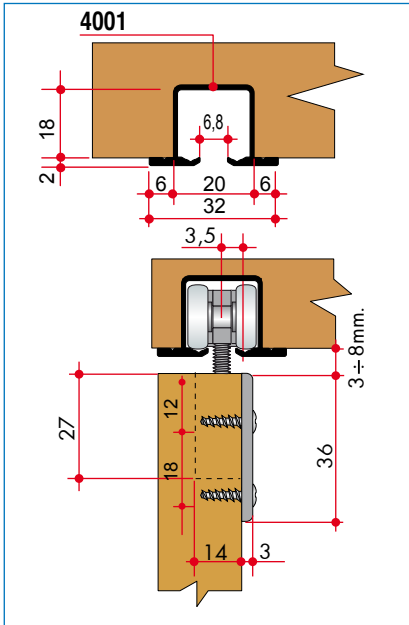
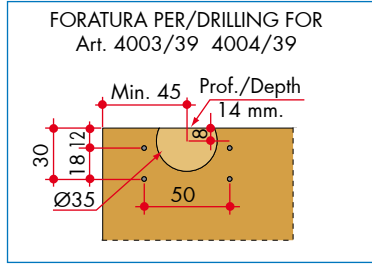
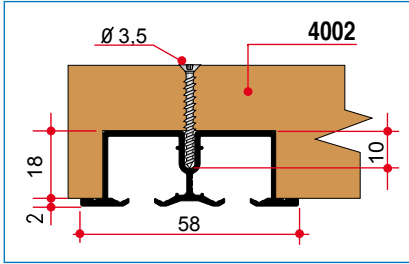

MONTARE PER PRIMA L'ANTA ESTERNA POI QUELLA INTERNA - ASSEMBLE THE EXTERNAL DOOR AND THEN THE INSIDE

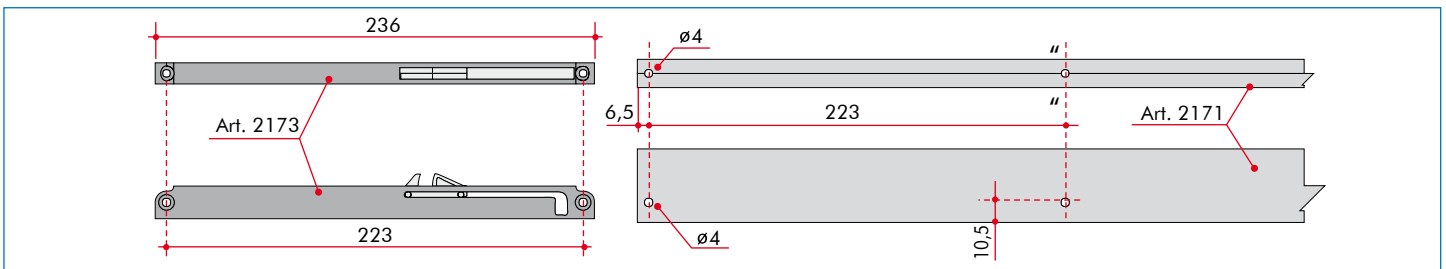
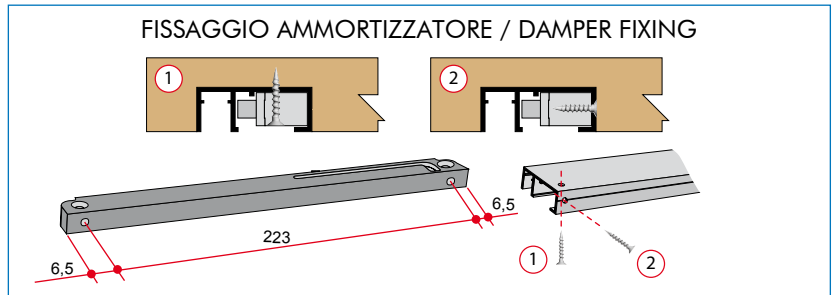
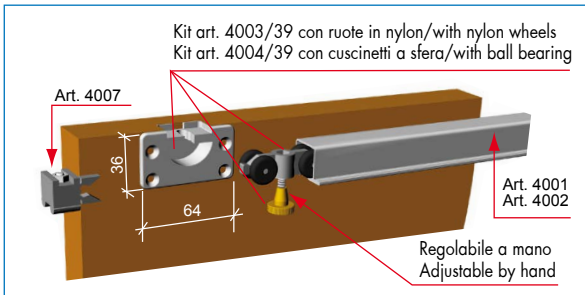

Per anta INTERNA con ruote in nylon For INTERNAL door with nylon wheels	Kit art. 4037/SX (LEFT) Kit art. 4037/DX (RIGHT)	Per anta ESTERNA con ruote in nylon For EXTERNAL door with nylon wheels	Kit art. 4038/SX (LEFT) Kit art. 4038/DX (RIGHT)
Per anta INTERNA con cuscinetti a sfera For INTERNAL door with ball bearings	Kit art. 4047/SX (LEFT) Kit art. 4047/DX (RIGHT)	Per anta ESTERNA con cuscinetti a sfera For EXTERNAL door with ball bearings	Kit art. 4048/SX (LEFT) Kit art. 4048/DX (RIGHT)
<p>SX</p> <p>4007/S</p> <p>4034/SX</p> <p>2172</p> <p>2173</p>	<p>DX</p> <p>4034/DX</p> <p>2172</p> <p>2173</p>	<p>SX</p> <p>4036/SX</p> <p>2173</p>	<p>DX</p> <p>4036/DX</p> <p>2173</p>