

# Serie 2200 C

## Per ante esterne

### For external doors



Sistema scorrevole frontale con fissaggio non visibile e senza necessità di predisposizione sul mobile  
 Frontal sliding system with not visible fixing  
 (Predisposition on the furniture is not necessary)



art. 2216 **KG 160\***  
 Carrello in acciaio, regolabile a 4 cuscinetti  
 Adjustable iron carriage with 4 bearings

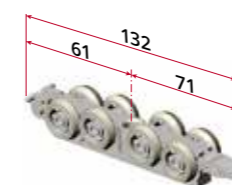

art. C/ACC8R **KG 160\***  
 Carrello in metallo con 8 cuscinetti a sfera  
 Metal carriage with 8 ball bearings

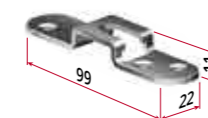

art. 2200  
 Staffa incassabile  
 Embedded bracket



art. 2200/Perno  
 Vite standard  
 Standard screw

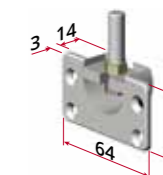

art. 2239 **KG 160\***  
 Staffa in metallo con incasso ø35 mm completo di perno M8  
 Metal bracket ø35 mm with threaded pin and nut M8

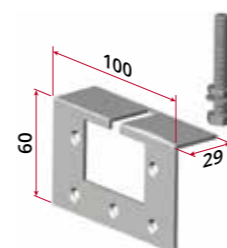

art. 2238 **KG 130\***  
 Staffa in acciaio con perno M8  
 Metal bracket with pin and nut M8



art. 2207  
 Fermo in nylon  
 Nylon stopper



art. 2249  
 Accessorio per fissaggio art. 2231 su 2235  
 Accessory for fixing art. 2231 on 2235

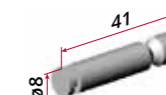

art. 3538  
 Perno ø8 per fissaggio art. 2231  
 Pin ø8 for fixing art. 2231



art. 3539  
 Barilotto ø14 per art. 3532  
 Fixing cylinder for art. 3532

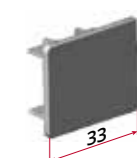

art. 2232  
 Tappo in metallo per art. 2231  
 Metal cap for art. 2231

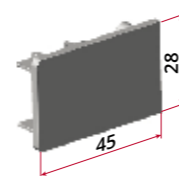

art. 2232/5  
 Tappo in plastica per art. 2231+2235  
 Plastic cap for art. 2231+2235

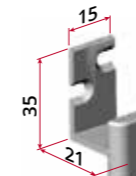

art. 3887  
 Guida inferiore in metallo per canalina art. 3525  
 Metal lower guide for art. 3525

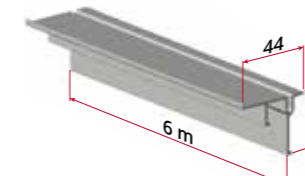

art. 2002  
 Binario inferiore in alluminio  
 Aluminium lower rail

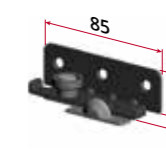

art. 2004  
 Guida inferiore  
 Lower guide

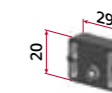

art. 2208  
 Fermo inferiore in nylon  
 Lower nylon stop



art. Diam 11  
 Guida inferiore in nylon ø11  
 Nylon lower guide ø11

## Descrizione componenti | Components description

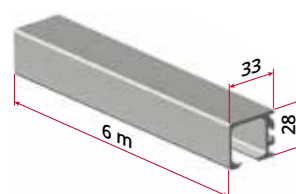

art. 2231  
 Binario in alluminio superiore/inferiore  
 Aluminium upper and lower rail

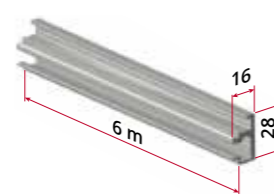

art. 2235  
 Profilo in alluminio per ancoraggio binario art. 2235  
 Aluminium profile for hooking the rail art. 2235

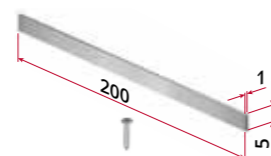

art. 2234  
 Lamella di fissaggio del binario art. 2231 sull'art. 2235  
 Reed for fixing rail art. 2231 on art. 2235

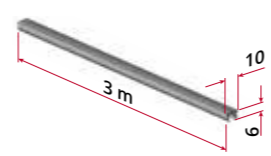

art. 4609  
 Guarnizione morbida per chiusura vano tra art. 2231 e 2235  
 Soft gasket for closing gap between art. 2231 and 2235

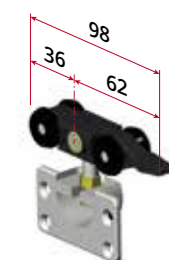

art. 2203/39 **KG 60\***  
 Carrello in nylon regolabile completo di staffa art. 2239  
 Nylon carriage adjustable with metal bracket art. 2239



art. 2216/39 **KG 160\***  
 Carrello in acciaio regolabile completo di staffa art. 2239  
 Steel carriage adjustable with metal bracket art. 2239

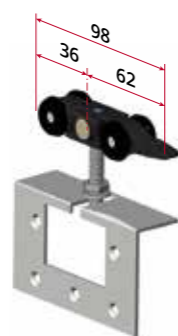

art. 2203/38 **KG 60\***  
 Carrello in nylon regolabile completo di staffa art. 2238  
 Nylon carriage adjustable with metal bracket art. 2238



art. 2216/38 **KG 160\***  
 Carrello in acciaio regolabile completo di staffa art. 2238  
 Steel carriage adjustable with metal bracket art. 2238

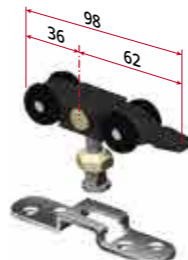

art. 2203 **KG 60\***  
 Carrello in nylon, regolabile  
 Nylon carriage adjustable

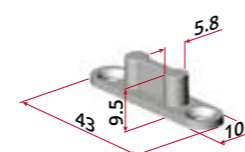

art. 4006  
 Pattino guida inferiore in nylon  
 Nylon lower guide



art. 3525 per/for art. 3887-4006  
 Profilo in PVC  
 PVC profile

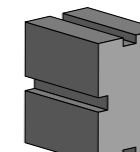

art. 220  
 Spugna pulisci binario utilizzabile anche su binari già installati  
 Cleaner rails sponge usable also in the rails already fixed



art. 10/13  
 Chiave fissa 10/13 mm per art. 2239  
 Fix key 10/13 mm for art. 2239



art. 2090  
 Chiave a brugola MM3  
 Allen key MM3

\* Le portate si intendono per coppia | Load capacity are per pair



# Informazioni tecniche | Technical informations

## A Binario art. 2231 fissato direttamente al mobile Rail art 2231 directly fixed on the cabinet

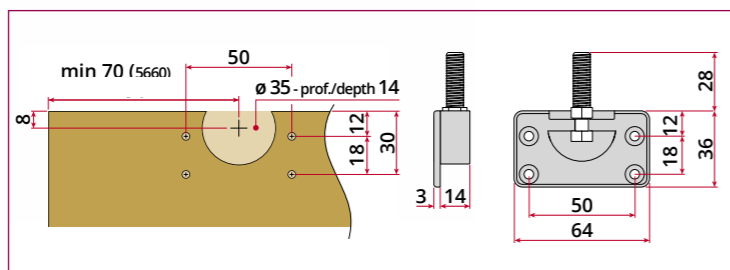
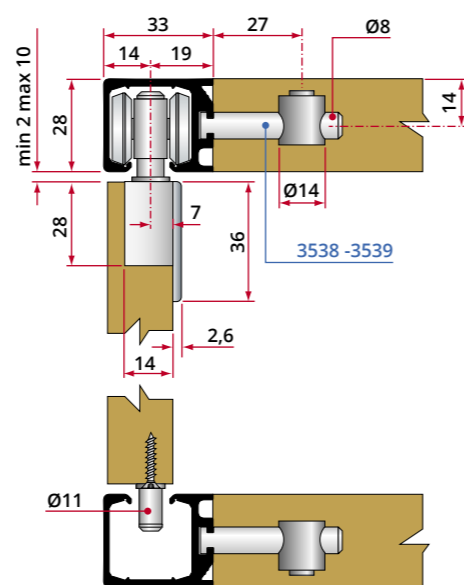
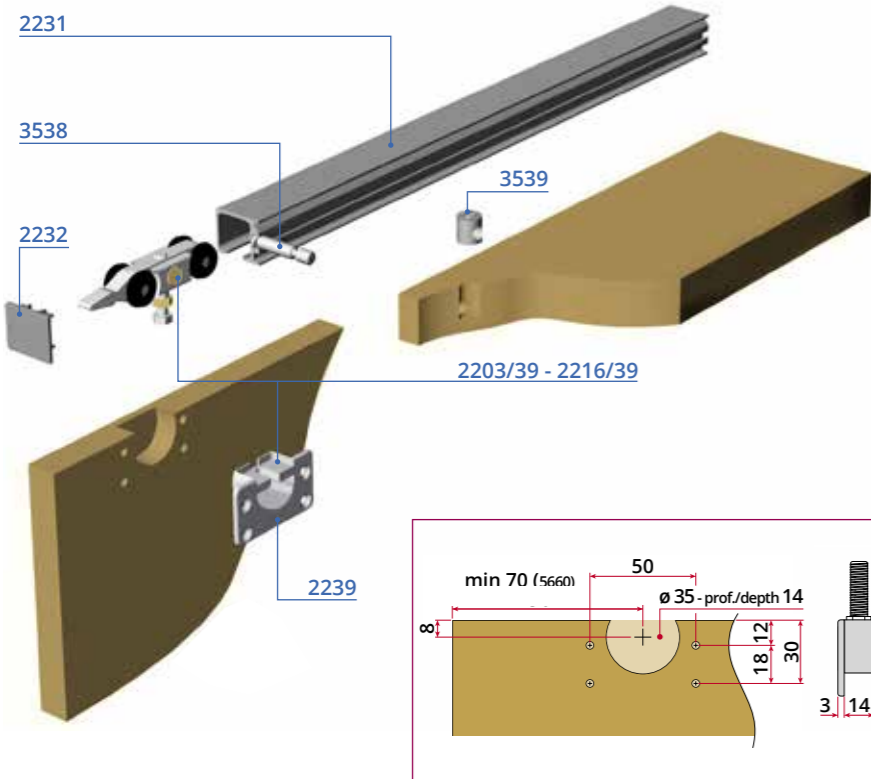

**Kit compatibili  
Matching kits**  
2210/39/EXT  
2230/39/EXT  
2211/23i

## B Binario art. 2231 fissato al mobile tramite profilo 2235 Rail art 223 fixed on the cabinet by art 2235

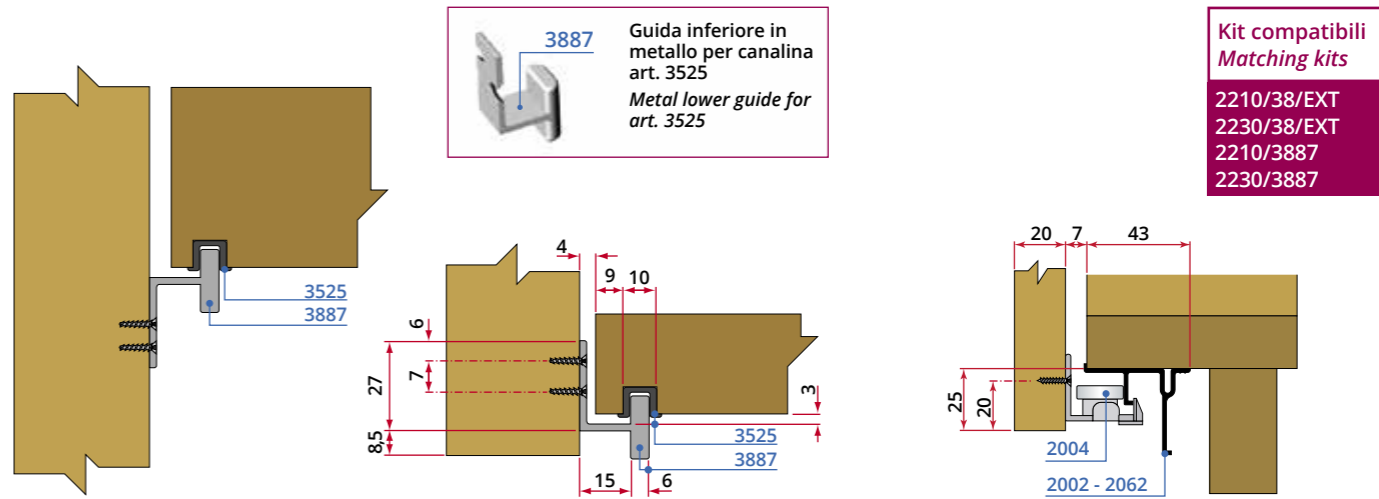
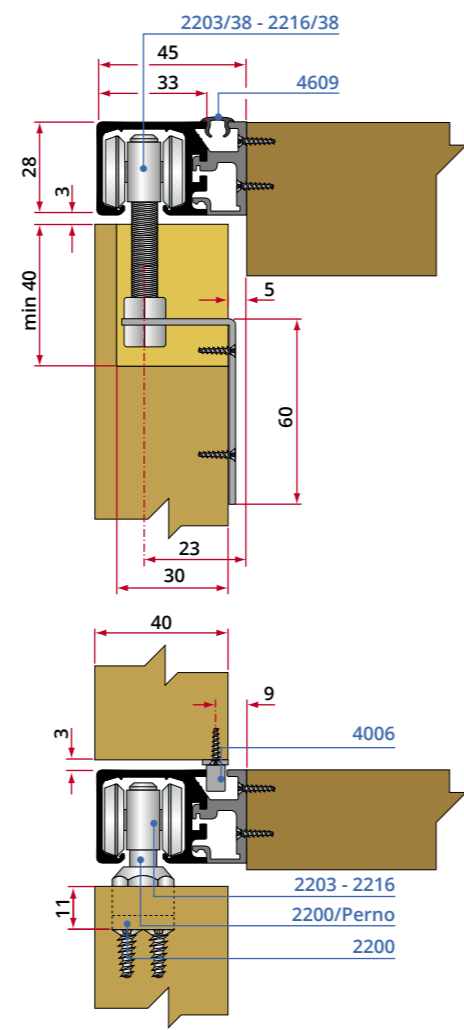
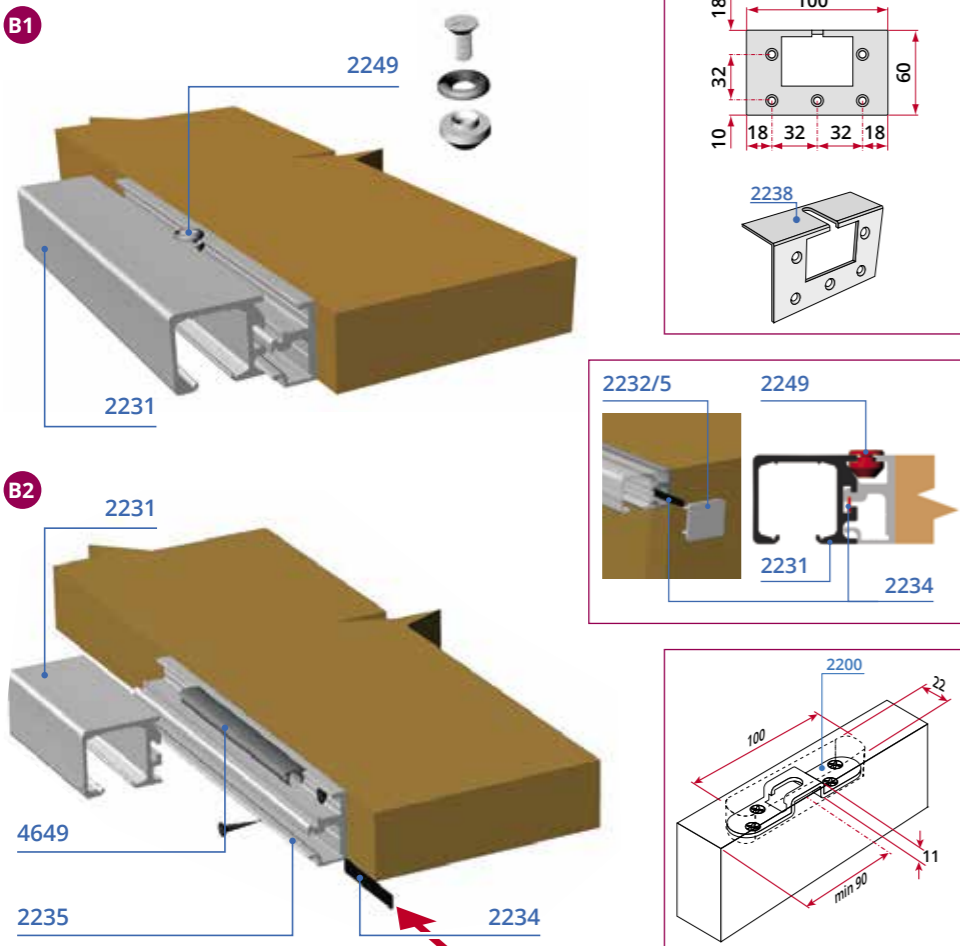

**Kit compatibili  
Matching kits**  
2210/38/EXT  
2230/38/EXT  
2210/3887  
2230/3887

## Lista Kit e profili principali | Kits list and main profiles

Art. 2231	Art. 2235	Art. 4609	Art. 3525
<b>2210/39/EXT</b>  Art. List: 2203/39 x2   2207 x2   DIAM.11 x2   10/13 x1   2090 x1 Kg 60, 779, 3000, 1, SOFT, AUTO	<b>2230/39/EXT</b>  Art. List: 2216/39 x2   2207 x2   DIAM.11 x2   10/13 x1   2090 x1 Kg 60, 779, 3000, 1, SOFT, AUTO	<b>2210/EXT38</b>  Art. List: 2203/38 x2   2207 x2   4006 x2   2090 x1 Kg 160, 815, 3000, 1, SOFT, AUTO	<b>2230/EXT38</b>  Art. List: 2216/38 x2   2207 x2   4006 x2   2090 x1 Kg 160, 400, 3000, 1, SOFT, AUTO
<b>2210/3887</b>  Art. List: 2203(2200) x2   2207 x2   3887 x2   2204 x1   2090 x1 Kg 160, 815, 3000, 1, SOFT, AUTO	<b>2230/3887</b>  Art. List: 2216(2200) x2   2207 x2   3887 x2   2204 x1   2090 x1 Kg 160, 400, 3000, 1, SOFT, AUTO	<b>2211/23i</b>  Art. List: 2211/39 x2   2207 x2   2004 x2   2008 x2   10/13 x1   2090 x1 Kg 100, 400, 3000, 1, SOFT, AUTO	

Serie 2200