

villes *made in italy* 2000

sistemi scorrevoli | *sliding systems*

Catalogo completo
disponibile sul nostro sito web

*Complete catalog
available on our website*

Sistemi scorrevoli | Sliding systems

Villes 2000

Mobile
Furniture



Porte
Doors



Box doccia
Shower box



03

Villes srl

Via Castoldi, 6/8 | 20090 | Trezzano sul Naviglio | Milano | Italy

tel +39 02 4452083 | fax +39 02 4452838

info@villess2000.com

www.villess2000.com



Dal | Since

1956



La nostra storia | Our history

La Villes nasce nel 1956 su iniziativa di nostro padre Pietro Paolo Villa,

persona molto intraprendente e creativa, da cui noi figli abbiamo appreso dinamicità ed entusiasmo, affrontando ogni nuova opportunità con impegno e determinazione.

Dalla sua nascita la Villes si è occupata di lavorazioni conto terzi e per questo motivo ha avuto l'opportunità di acquisire una **vasta e importante esperienza nelle lavorazioni meccaniche di ogni genere.**

In più di 60 anni di attività la nostra azienda ha prodotto gli articoli più svariati.

Fra questi compaiono cornici per quadri in alluminio con anima interna in legno, catenelle metalliche, cerniere a nastro per mobili, profilati in metallo per radio e TV prodotti con macchinari a rulli da noi progettati, cerniere in acciaio per elettrodomestici, antenne telescopiche elettriche per auto, plance per autoradio estraibili, piccoli ricambi di carrozzeria per auto, altoparlanti, circuiti stampati micro forati, contatti elettrici di ogni genere, profili in alluminio lavorati a disegno, maniglie per mobili, stampi e attrezzature per ogni esigenza, e tanti altri.

Dopo avere acquisito un'importante esperienza in questo settore, **nel 1991 la Villes si trasforma nell'attuale brand "Villes2000"** e al tempo stesso

lancia sul mercato una linea di sistemi interamente progettati, realizzati e commercializzati autonomamente.

In occasione dell'esposizione internazionale SASMIL di Milano, a cui partecipa nel 1996, la Villes2000 acquisisce immediatamente numerosi clienti internazionali, rivelando da subito la **sua natura di azienda esportatrice**, valore ancora oggi alla base della sua filosofia commerciale.

Villes was established in 1956 by our father Pietro Paolo Villa, a creative entrepreneur who taught his sons dynamism and enthusiasm and to approach every new opportunity with dedication and resolution. Since the beginning Villes has been working on behalf of third parties and for this reason it had the opportunity to acquire a wide and valuable experience in mechanical processing of all kinds.

In more than 60 years of activity our company has produced the most varied items. Among these you will find aluminum frames for pictures with internal wooden core, metal chains, band joints for furniture, metal extrusions for radio and TV produced with in-house design roller equipments, steel joints for household appliances, electric telescopic antennas for cars, dashboards for removable car radios, small spare parts for car bodies, speakers, micro perforated printed circuits, electrical contacts of all kinds, customized aluminium profiles, furniture handles, molds and equipments for every need, etc.

After acquiring an important experience in this field, in 1991 Villes transformed into the new brand "Villes2000" and at the same time it launched on the market a new full range of systems entirely designed, manufactured and marketed independently.

During the SASMIL international exhibition in Milan, attended since 1996, Villes2000 acquires many foreign customers, reinforcing itself as an exporting company, that is still one of the main elements of its current commercial strategy.



Dal | Since
1956

Copertura del mercato internazionale

International market coverage

Esportiamo più del 55% dei nostri prodotti, garantendo così la necessaria sicurezza commerciale ed economica alla nostra azienda.

Questo ci permette di investire ogni anno per lo sviluppo di nuovi sistemi e nello stock a magazzino, garanzia di una veloce evasione degli ordini.

Avere acquisito molti clienti in tutto il mondo ci permette di compensare e stabilizzare i frequenti sobbalzi dell'attuale sistema economico mondiale, spesso instabile e soggetto a improvvisi periodi di crisi e di rilanci delle singole economie nazionali.

Operiamo, oltre che in **Europa**, a **Singapore, Taiwan, Hong Kong, Canada e Sud America, India, Nord Africa, Medio Oriente e Russia**: tutti mercati in crescita, che ci stanno dando molte soddisfazioni e su cui contiamo molto per il futuro.

We export more than 55% of our volumes, and this gives a significant contribution to the commercial and financial solidity of our company.

This allows us to invest each year for the development of new systems, and in the stock, in order to guarantee a short lead time of delivery.

The internationality of our customers allow us to compensate and stabilize the current instability of the global economic system, that suffers from frequent and sudden cycles of up and down in the different market economies.

Our main markets, besides **Europe**, are **Singapore, Taiwan, Hong Kong, Canada and South America, India, North Africa, Middle East, Russia**. All these development countries are giving us a lot of satisfaction and we rely a lot on them for the future.

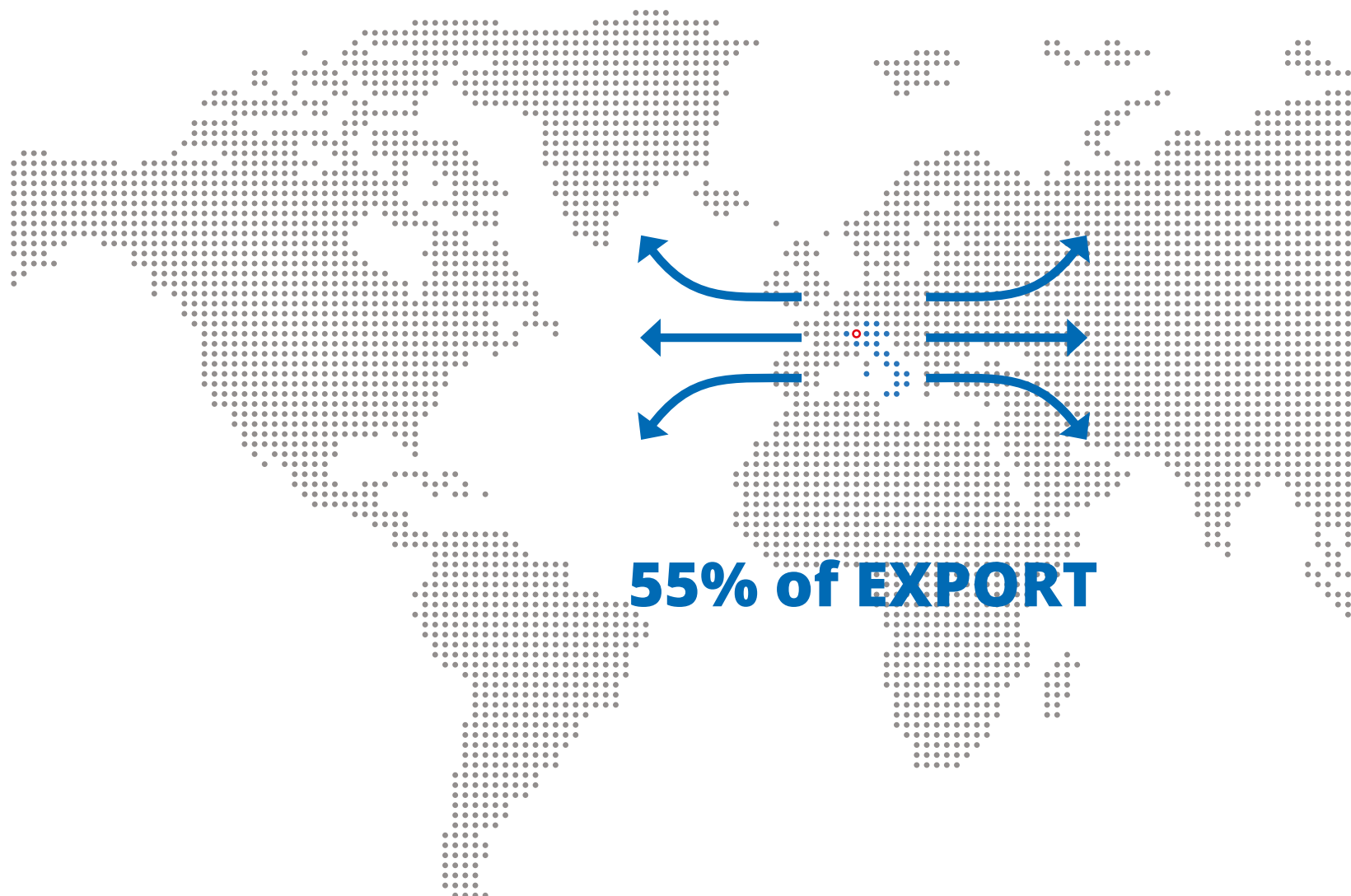

L'importanza del made in Italy

The relevance of the Made in Italy

**Progettiamo e produciamo
esclusivamente nella nostra sede italiana**

*We design and produce
only at our Italian headquarter*

**“Qualità” e “Made in Italy” sono
importanti aspetti a cui teniamo in
particolare modo.**

Produrre in Italia è sicuramente molto più costoso rispetto ad altri Paesi, ma poter controllare tutte le fasi di progettazione, prototipazione, produzione e test direttamente all'interno della nostra sede è fondamentale per garantire la qualità e la velocità di consegna che i nostri clienti ci richiedono.

**“Quality” and “Made in Italy” are key
elements we care a lot about.**

Producing in Italy is certainly much more expensive compared to other countries, but we consider critical to be able to control all the steps - design, prototyping, manufacturing and testing - directly in our headquarter. This allows us to ensure the quality and short delivery times that our customers require.



I fattori chiave del nostro servizio

The key drivers of our service

La nostra azienda è **sempre alla ricerca di nuove soluzioni tecniche**, spesso inedite, che ci permettono di non avere competitor diretti sul mercato e di avere convincenti argomenti di supporto alla vendita.

Per garantire un servizio all'altezza delle esigenze dei nostri clienti impieghiamo **grandi risorse ed energie nel mantenere un magazzino ben fornito**, che ci consenta di essere sempre molto veloci nell'evasione degli ordini.

Inoltre disponiamo di un **reparto tecnico sempre disponibile ad aiutare i nostri clienti** a trovare la soluzione più idonea ad ogni loro esigenza, e all'occorrenza anche a realizzare articoli "su misura".

*Our company is **always looking for new innovative technical solutions**, which allow us to win the competition in the market and to support the sales arguments.*

***We invest a lot in the stock**, in order to be always ready to respond to our customer's needs and to guarantee the fastest delivery of our orders.*

*We also have a **technical department always available in helping our customers** to find the best solution for their needs. We can also produce custom made items.*



Sostenibilità e sicurezza

Sustainability and safety

Lavoriamo sempre in sicurezza
e nel rispetto dell'ambiente
*Safety and environment sustainability
are our priorities*



In ottica di sostenibilità ambientale e rispetto ecologico, nel 2011 la Villes srl si dota di un **moderno impianto fotovoltaico, che ne garantisce la completa autonomia energetica.**

Sofisticate procedure di controllo qualitativo e rigorosi test sui prodotti garantiscono sempre l'estrema qualità e durezza dei nostri articoli, nel pieno rispetto delle norme vigenti.

*In line with its environmental sustainability approach, in 2011 Villes furnished itself with a **modern photovoltaic system, which makes it totally autonomous from an energetic stand point.***

Sophisticated quality controls and rigorous product testing procedures always guarantee the highest quality and durability of our products, fully compliant with the current legislation.





Lavoriamo spesso a fianco di architetti e progettisti e **collaboriamo attivamente con i leader di mercato**, al fine di recepire in anticipo le nuove tendenze di design, e **sviluppare insieme a loro prodotti** che poi incontreranno interesse e consensi da parte di tutta la nostra clientela.

A dimostrazione del nostro impegno verso l'innovazione **abbiamo fino ad ora già depositato 15 brevetti e registrato il nostro brand** in diversi paesi.

*We usually work with architects and designers and **we proactively collaborate with market leaders**, in order to capture in advance the new design trends and develop with them new products that satisfy our customers' needs and demand. In accordance with our commitment to innovation so far **we have already 15 certified patents and we registered our trademark** in many countries.*



ATTESTATO DI BREVETTO PER INVENZIONE INDUSTRIALE

N. 0001413634

Il presente brevetto viene concesso per l'invenzione della domanda sotto specificata:

num. domanda	anno	C.C.I.A.A.	data pres. domanda	classifica
001671	2012	MILANO	05/10/2012	E05D15 06

TITOLARE/I VILLES S.R.L.
TREZZANO SUL NAVIGLIO (MI)

MANDATARIO LUNATI VITTORIANO

INDIRIZZO LUNATI & MAZZONI S.R.L.
VIA CARLO PISACANE 36
20129 MILANO

TITOLO DISPOSITIVO DI SCORRIMENTO PER PORTA SCORREVOLE

INVENTORE/I VILLA FRANCO



Roma, 30/01/2015



18 FEB. 2015

L'Ufficiale Rogante
G. SURACI

COPIA CONFORME ALL'ORIGINALE
FIRMATA DIGITALMENTE DAL
DIRIGENTE DELL'U.I.B.M.

IL DIRIGENTE
Dr.ssa Loredana Guglielmetti

Uno sguardo sempre in avanti

Looking always ahead

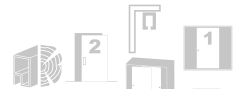

Evoluzione del brand

Brand evolution



Comunicazione ed eventi

Communication and events



Lavoriamo costantemente sulla comunicazione collaborando con qualificati professionisti, per un rinnovamento coordinato della nostra immagine grafica sia cartacea che web.

We constantly work on communication by collaborating with qualified professionals, in order to renovate our corporate image.



La nostra produzione | Our production



Mobile Furniture

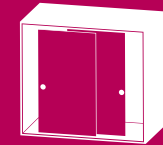

Porte Doors



Box doccia Shower box



Vantiamo 48 linee di prodotti, da noi denominate "Serie".
Tutti questi sistemi ci consentono di gestire qualsiasi tipo di movimentazione di ante per armadi, porte e box doccia.
Investiamo costantemente molte delle nostre risorse in ricerca e sviluppo, per dotarci di innovazioni tecniche sempre all'avanguardia.

We have 48 product lines, which we call "Series."
All these systems allow us to manage any kind of movements for cabinets doors, interior doors and shower box.
We constantly invest many of our resources in research and development, that aim to equip ourselves with cutting-edge technical innovations.



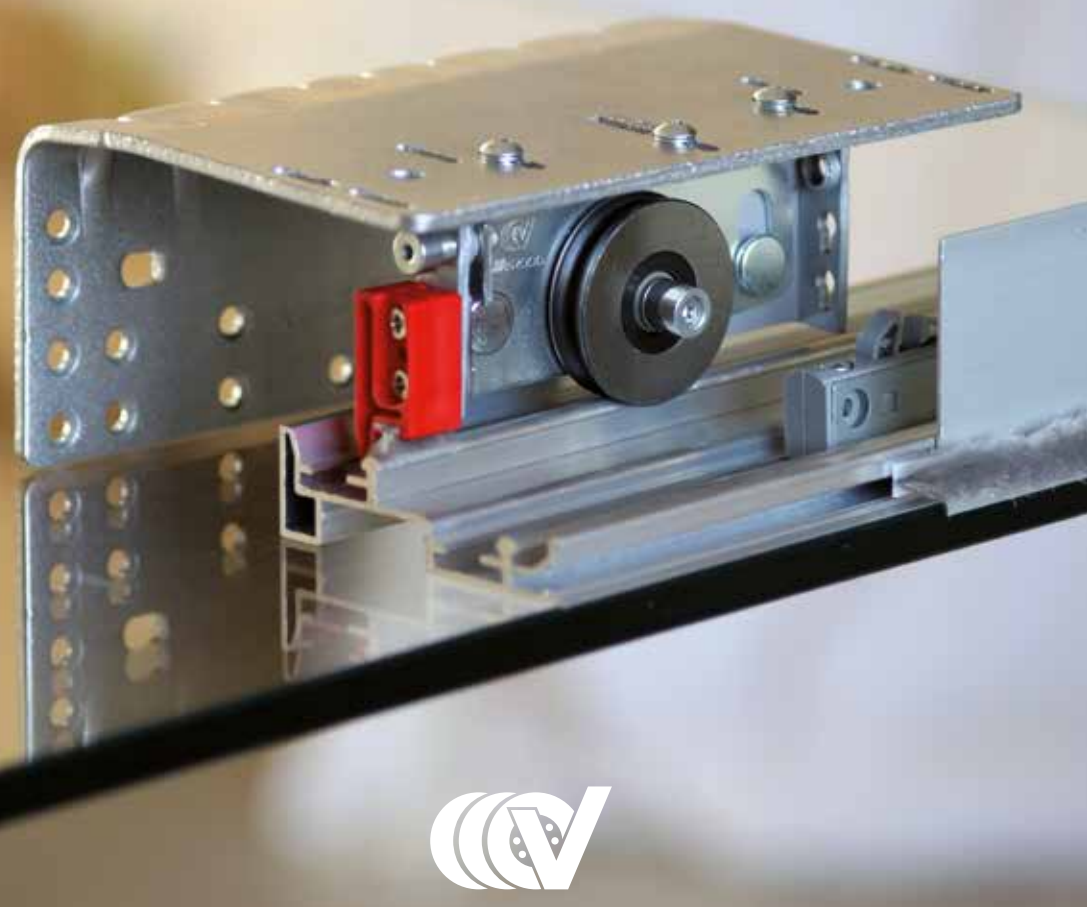

Categorie | Categories

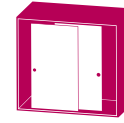

Mobile | Furniture



Porte | Doors

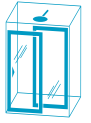

Box doccia | Shower box

Finiture | Finishes

A

Argento
Silver

B

Bronzo
Bronze

BI

Bianco
White

CL

Cromo lucido
Bright chrome

G

Grezzo
Untreated

GO

Grigio
Grey

IX

Inox
Stainless

M

Marrone
Brown

N

Nero
Black

NK

Nichelato
Nickel-plated

O

Ottone
Brass

TR

Trasparente
Transparent

Z

Zincato
Zinc-plated

A richiesta

On demand

Caratteristiche tecniche | Technical features



Legno & Metallo
Wood & Metals



Vetro
Glass



Spessore Min + Max
Min + Max thickness



Portata massima
Maximum weight capacity



Brevettato
Patented



Larghezza anta (Min + Max)
Door width (Min + Max)



N. ante | Doors N.



N. Porte | Doors N.



Anta interiore esterna
External inside door



Anta interiore interna
Inner inside door



Anta esteriore esterna
External outside door



Anta esteriore interna
Inner outside door



Soft-close singolo
Single soft-close



Soft-close doppio
Double soft-close



Automatismo senso unico
One way automatism



Automatismo doppio senso
Double way automatism

Collocazione porte | Doors position



Soffitto | Ceiling



Parete | Wall



Cartongesso
Plasterboard

Collocazione Box doccia | Shower box position



Muro-Muro
Wall to wall



Muro-Vetro
Wall to glass



Vetro-Vetro
Glass to glass



Angolo
Corner



Serie 2000

Link to

Serie 4400 | 5100



Sistema regolabile per armadi con ante scorrevoli
esteriori sovrapposte

*Adjustable system for wardrobes with overlapping external
sliding doors*

**Mobile
Furniture**

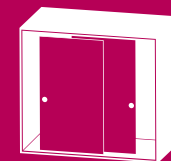



Serie 2100

**Mobile
Furniture**

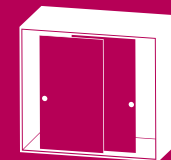

Sistema scorrevole regolabile o fisso per armadi con ante interne

Adjustable or fixed sliding system for wardrobes with internal doors

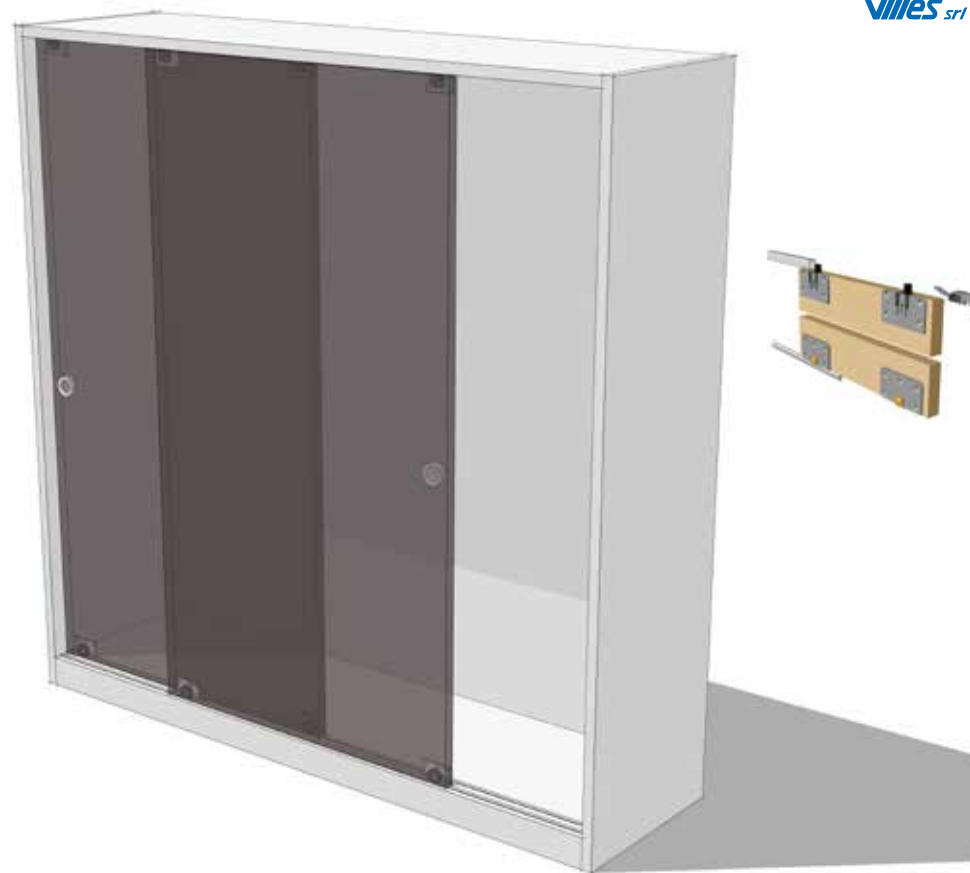

Villes *made in Italy* 2000



Villes srl

Serie 2200

**Mobile
Furniture**

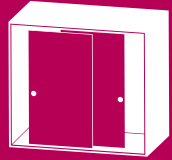

Sistemi e applicazioni speciali per mobili

System and special applications for furnitures





Serie 2300

**Mobile
Furniture**



Sistema regolabile per armadi con ante scorrevoli
esteriori sovrapposte, registrabile per ogni spessore di ante

*Adjustable system for wardrobes with overlapping external
sliding doors, adjustable for each door thickness*

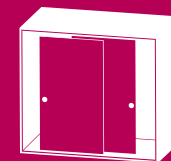



Serie 2600



Sistema raddrizza ante con struttura tubolare
in alluminio e carrello antistrisciamento

Door straightening system with aluminium tubular
structure and anti-scraping carriages

**Mobile
Furniture**

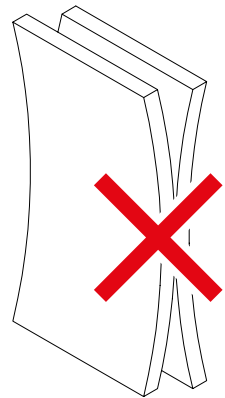
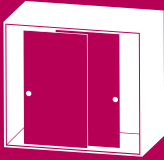



Serie 2800

**Mobile
Furniture**



Sistema scorrevole per armadi con ante interne sospese,
adatto ad ogni spessore

*Sliding system for wardrobes with internal hanging doors,
adaptable for any thickness*

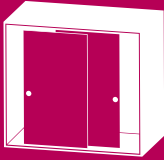



Serie 2900 EVO

Mobile
Furniture

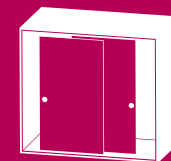

Sistema pieghevole e scorrevole per armadi e cabine spogliatoio

Folding and sliding system for wardrobes and walk-in closets





Serie 3200

Link to

Serie 2100



**Mobile
Furniture**

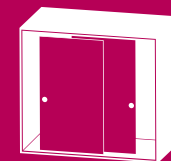

Sistema scorrevole con carrelli inferiori con battuta e a scomparsa

Sliding system with lower carriages with doorstop and foldaway

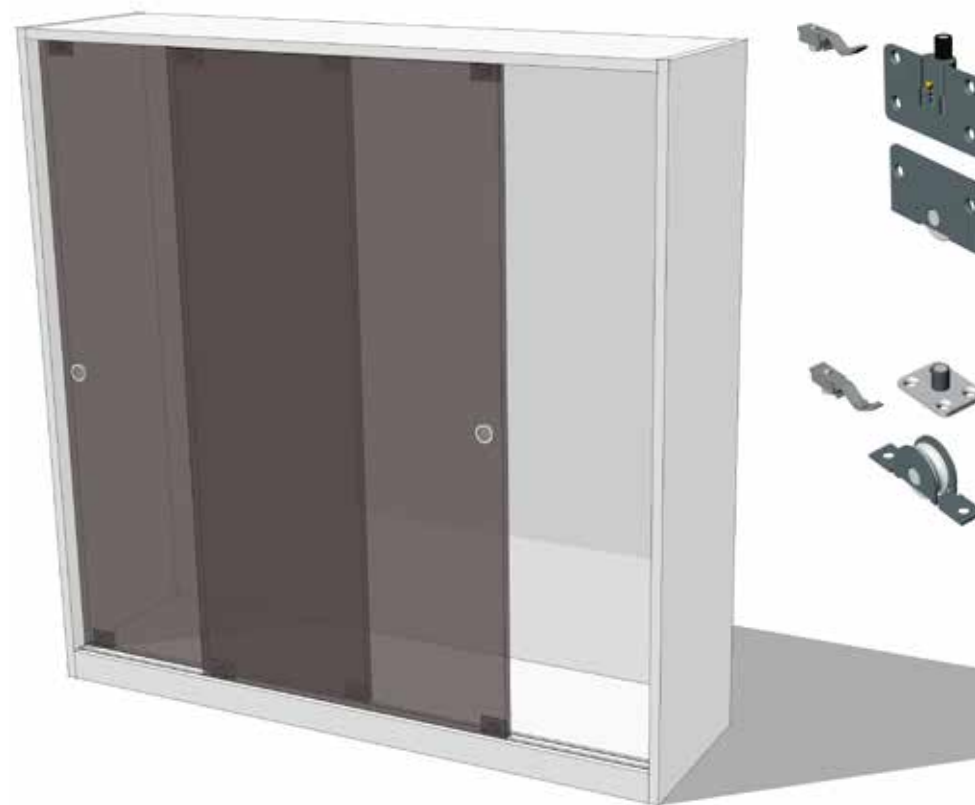

Serie 3300

**Mobile
Furniture**

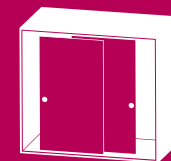

Sistema scorrevole monobinario per ante interne sospese

One-rail sliding system for hanging internal doors

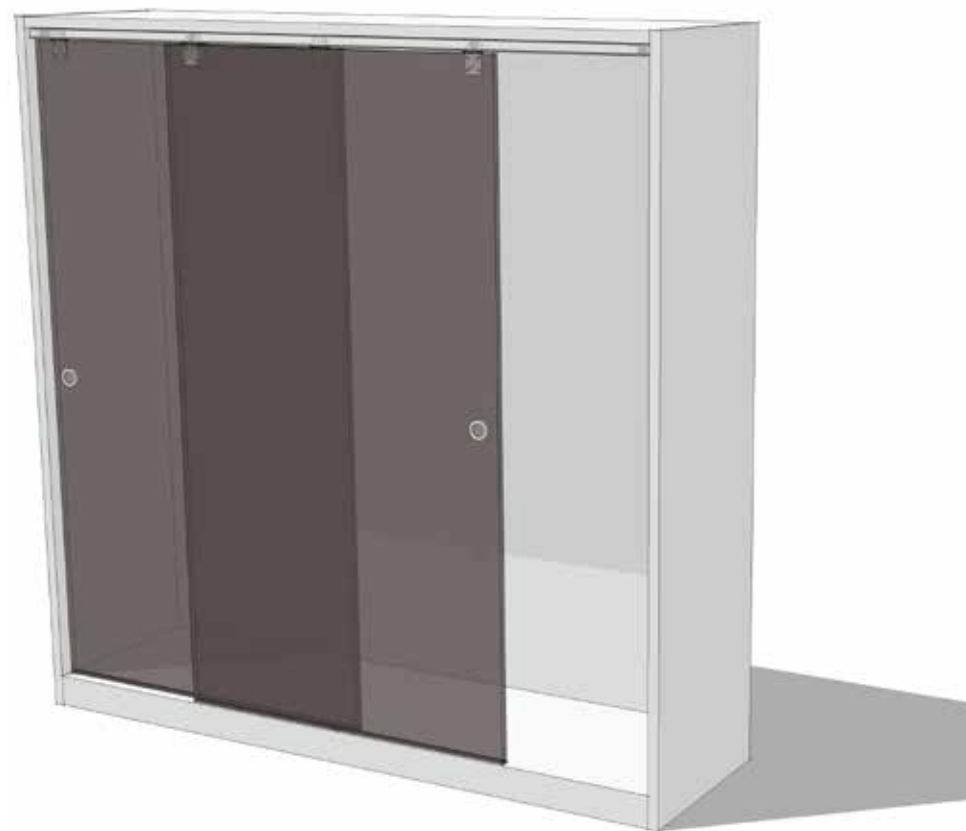



Serie 3500

**Mobile
Furniture**



Sistema scorrevole invisibile per ante in legno, vetro
o con telaio in alluminio

*Invisibile sliding system for wooden and glass doors
or with aluminium frame*

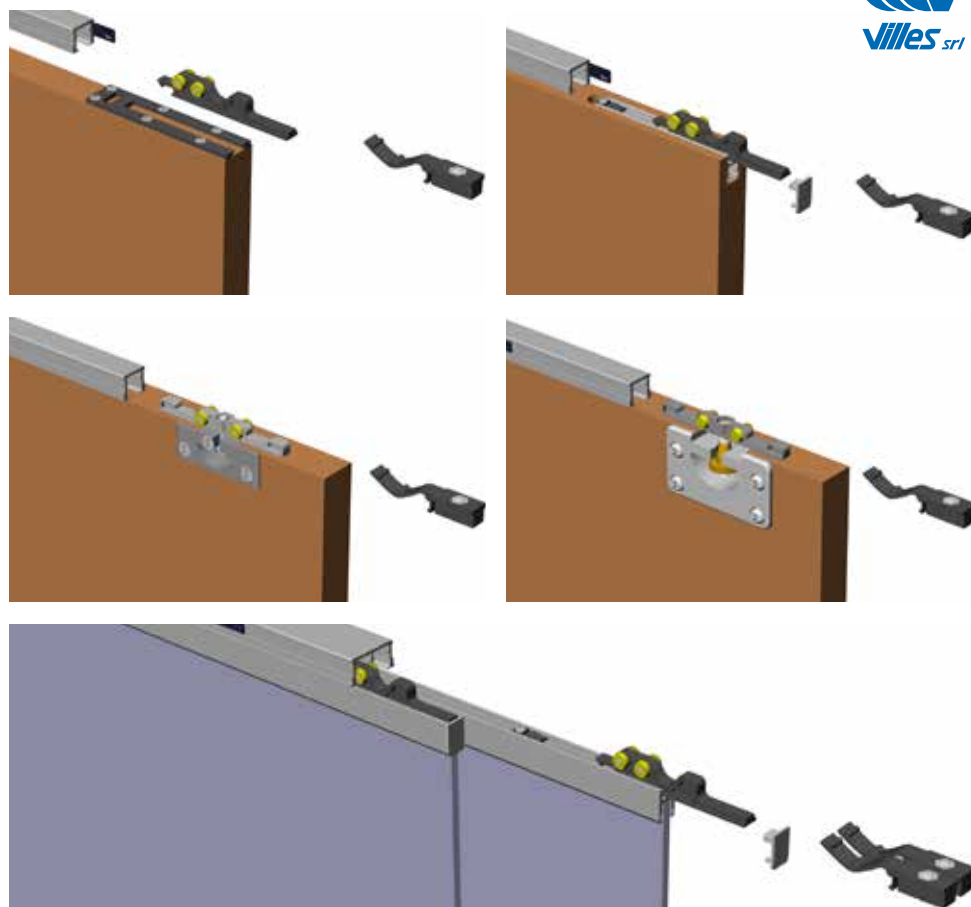
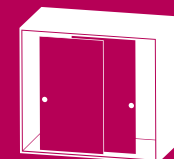



Serie 3700

Link to

Serie 2200



**Mobile
Furniture**



Sistema scorrevole per letti e scrivanie

Sliding system for beds and desks

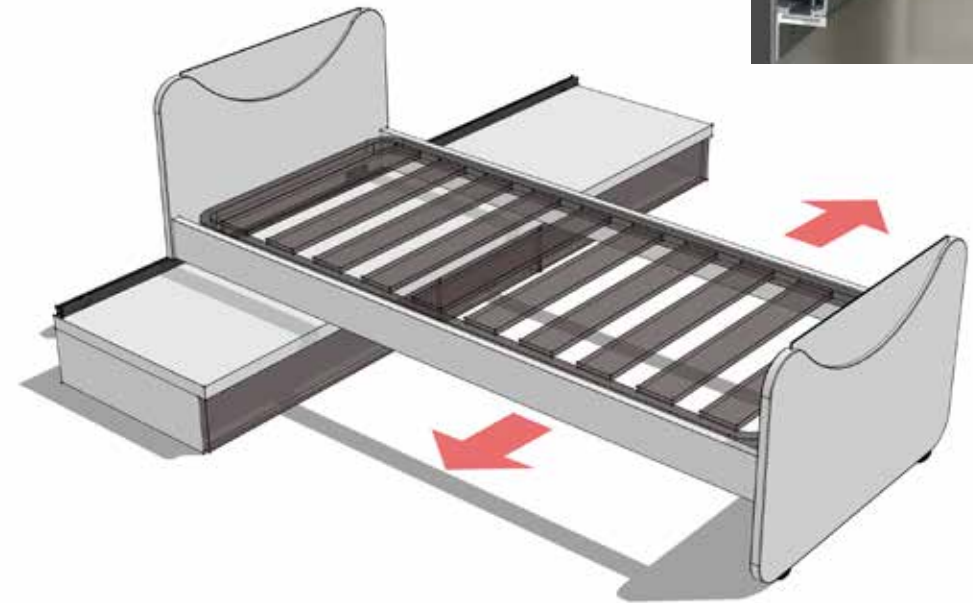



Serie 3900

**Mobile
Furniture**

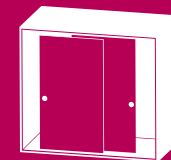

Sistema scorrevole regolabile per ante in legno, vetro e alluminio

Adjustable sliding system for wooden, glass and aluminium doors

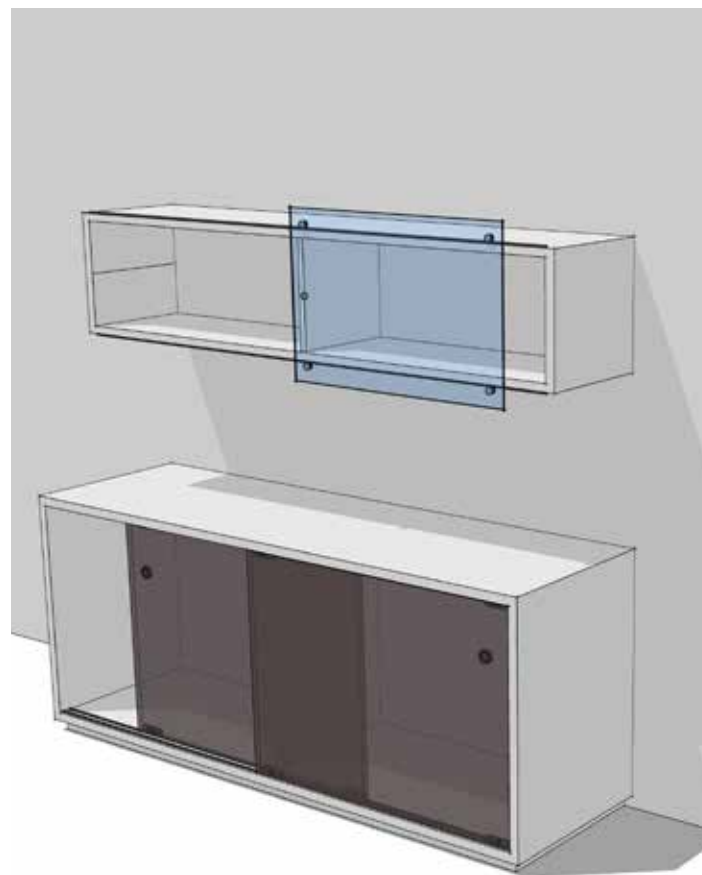

Villes *made in Italy* 2000



villes srl

Serie 4000

**Mobile
Furniture**



Sistema scorrevole per ante appese, in legno
o con telaio in alluminio

*Sliding system for hangingn wooden doors
or with aluminium frame*

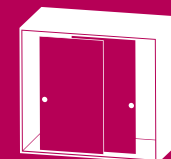

villes srl





Serie 4100

**Mobile
Furniture**



Sistema scorrevole per la divisione di ambienti
con ante a tutta altezza

*Sliding system for rooms partition
with full-height doors*

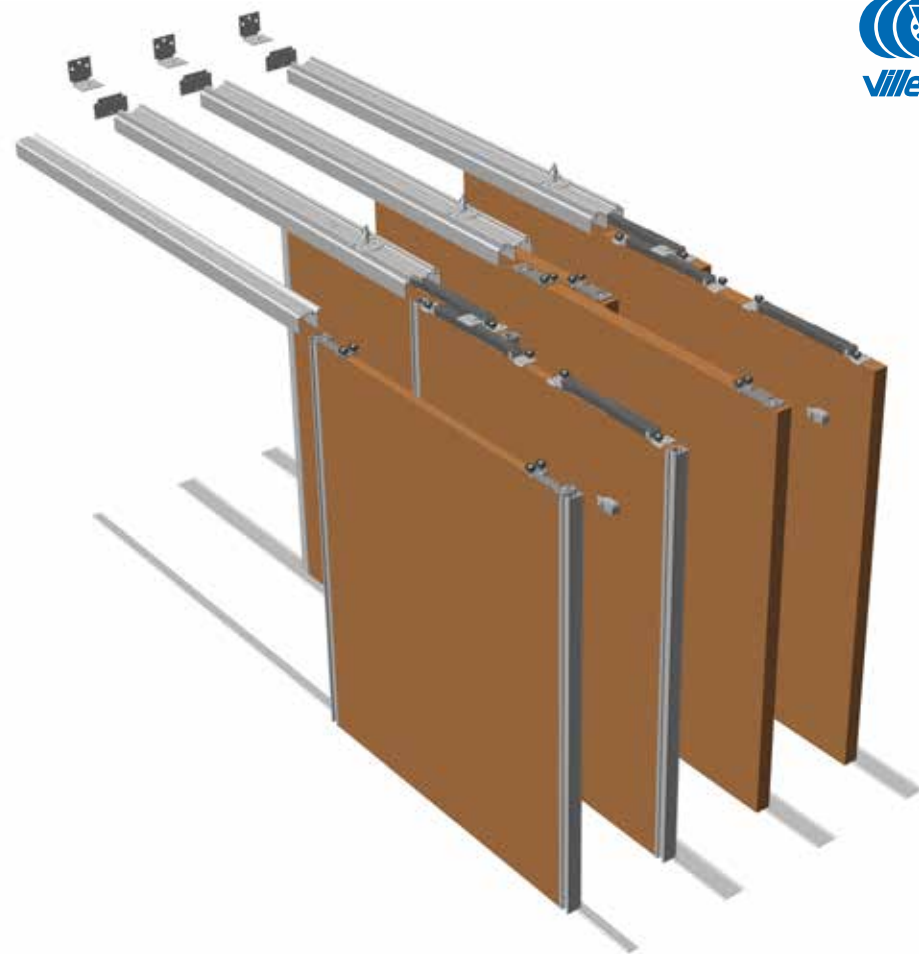
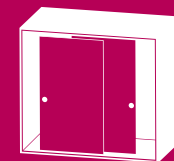

Villes *made in Italy* 2000



Serie 4300

**Mobile
Furniture**



Sistema scorrevole per ante sovrapposte in vetro
con cornice esterna al vano

*Overlapping sliding system for glass doors
with frame external to unit*

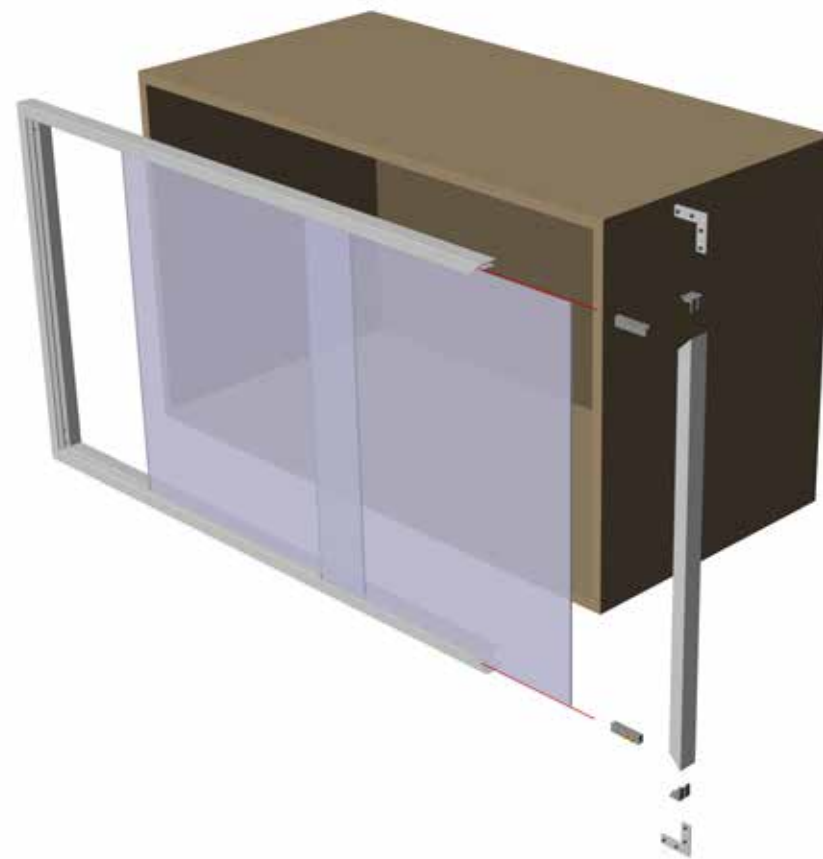
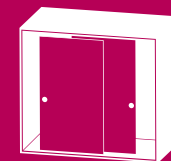



Serie 4400

Link to

Serie 2000 | 5000



Sistema scorrevole regolabile per ante sovrapposte di grandi dimensioni

Adjustable sliding system for wardrobes with overlapping large doors

Mobile Furniture





Serie 4600

Mobile Furniture

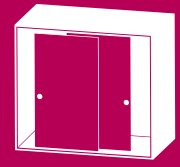
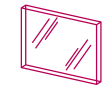

Struttura in alluminio con accessori per la realizzazione di mobili, scaffali e cabine armadio

Aluminium structure with accessories for the realization of furniture shelves and walk in closet





Serie 5000

Link to

Serie 4400 | 5300



Automazione per mobili ad ante scorrevoli esterne

Automation for wardrobes with external sliding doors

Mobile
Furniture

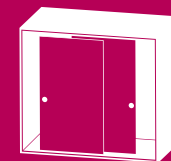



Serie 5100

Link to

Serie 2000 | 5300



Sistema di chiusura automatica e rallentata
per mobili con ante scorrevoli

*Automatic and slowed closing system
for furniture with sliding doors*

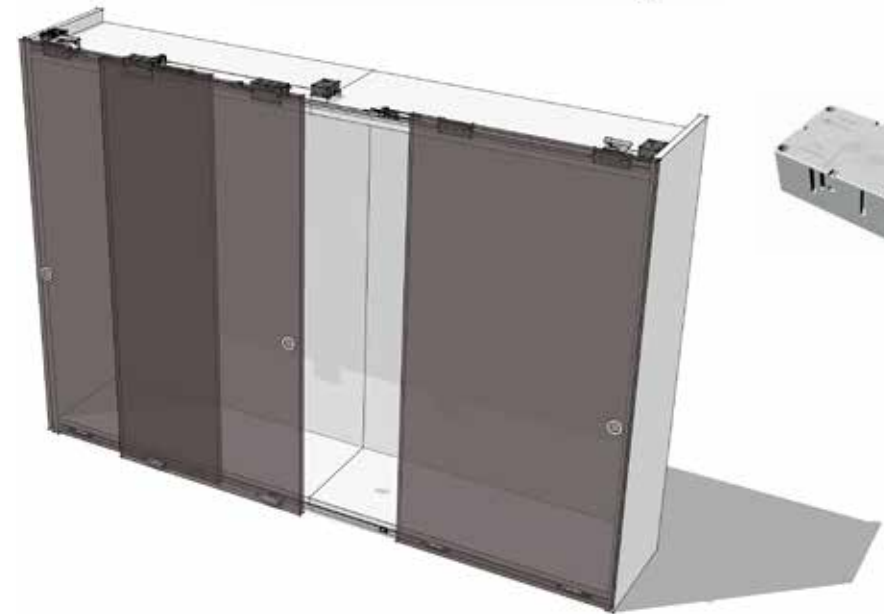

**Mobile
Furniture**

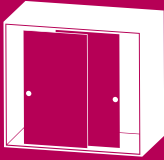



Serie 5300

 Link to

Serie 5000 | 5100



Sistema premium per armadi con ante scorrevoli
esteriori sovrapposte, con meccanismo nascosto

*Premium system for wardrobes with overlapping external
sliding doors, with hidden mechanism*

**Mobile
Furniture**

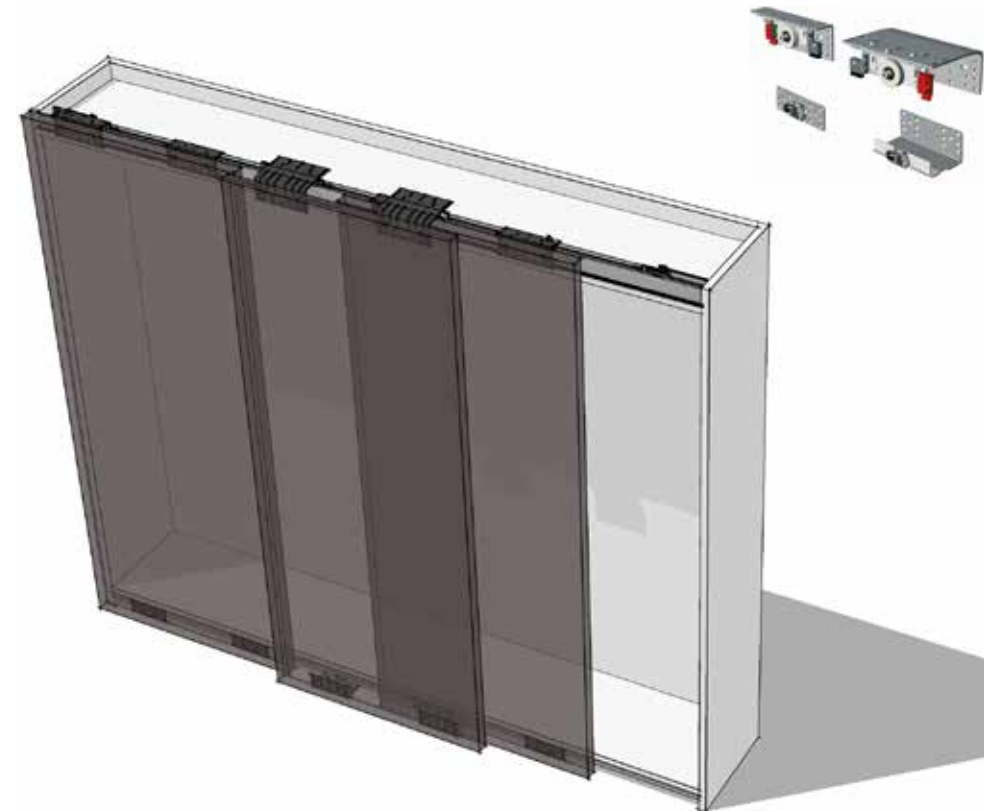



Serie 6100

**Mobile
Furniture**



**Sistema scorrevole ammortizzato per armadi e cabine armadio,
con ante interne**

*Sliding system with shock-absorber for wardrobes and walk-in
wardrobes with internal doors*

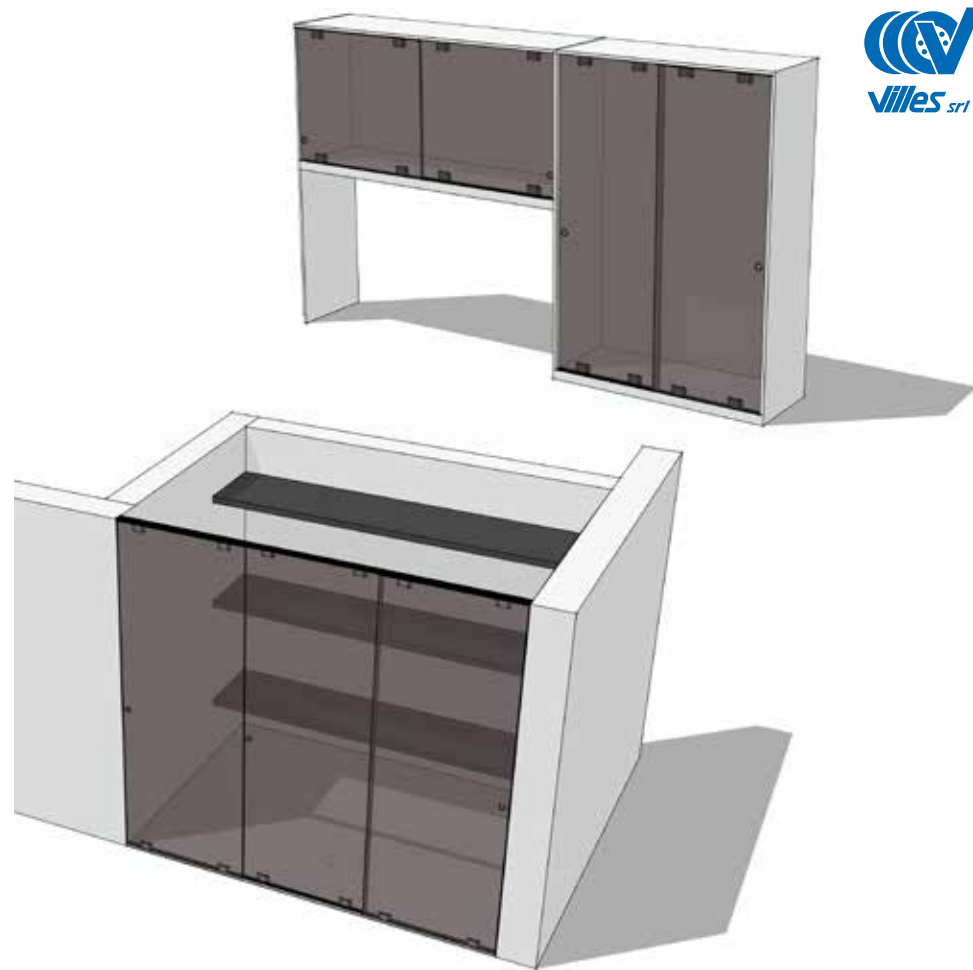
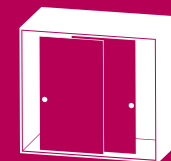



Serie 6600

Mobile Furniture



Sistema pieghevole ad apertura totale

Full-opening folding system

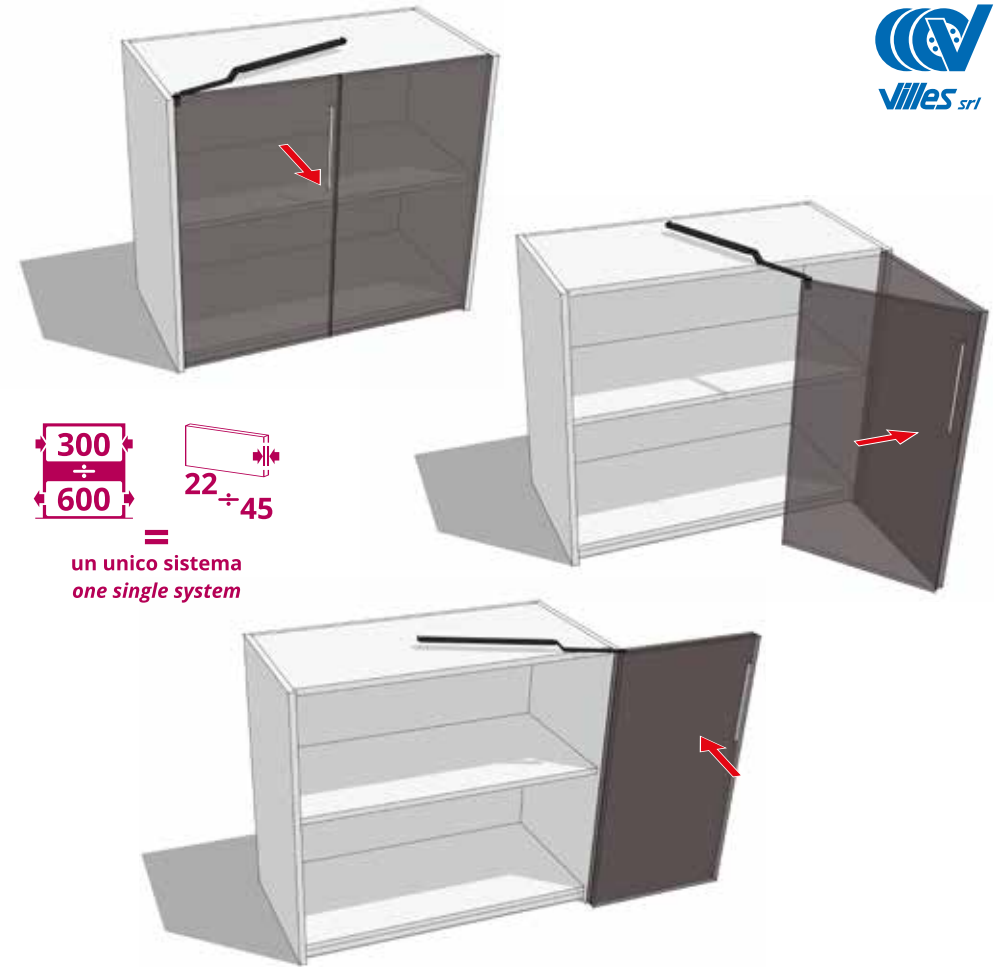
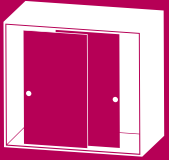

un unico sistema
one single system



Serie 2200

Link to

Serie 2700 | 5000 | 5500 | 5700



Sistema scorrevole per porte standard o con soft close,
da 40 a 160 kg

*Sliding system for standard doors or equipped with soft close,
from 40 to 160 kg*

Porte
Doors

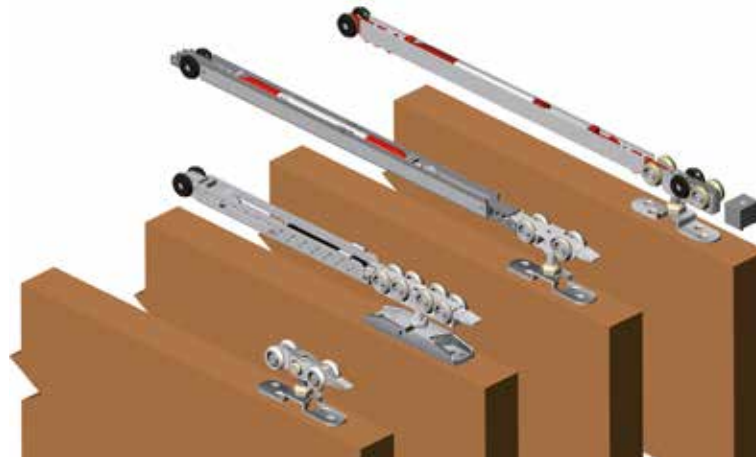



Serie 2500

[Link to Serie 3100](#)



Porte
Doors

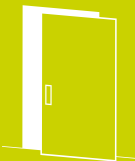

Meccanismo per porte pieghevoli, divise in due parti diverse

Folding doors equipment, divided in two different parts



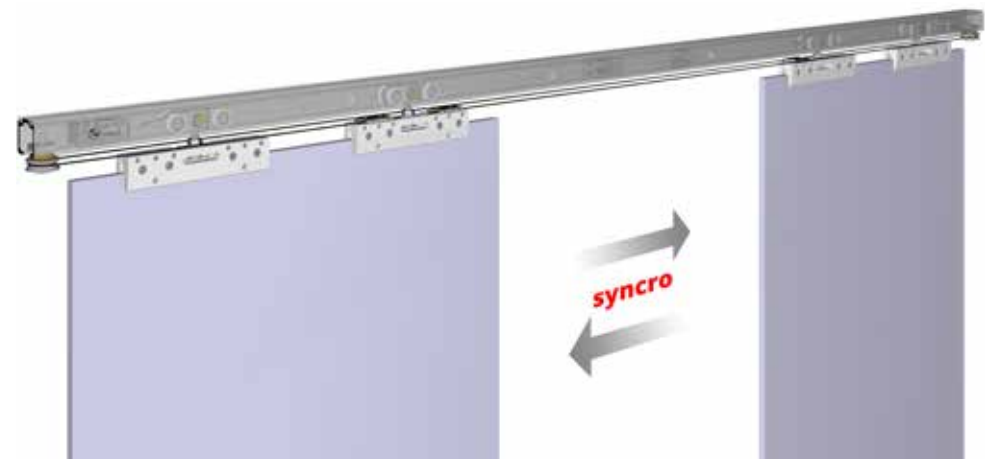

Serie 2700

 Link to [Serie 2200 | 5800](#)



Meccanismo di collegamento per l'apertura e la chiusura simultanea di due porte o persiane scorrevoli

Connection system for simultaneous opening and closing of two sliding doors or blinds

Porte
Doors

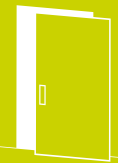

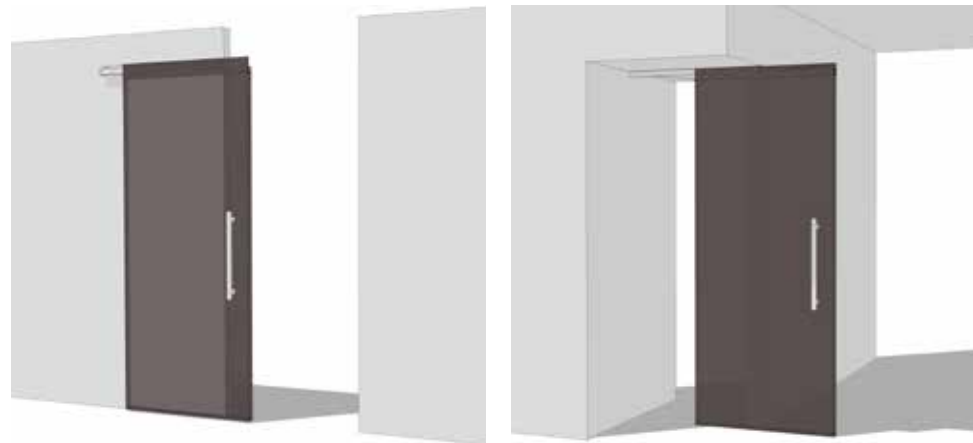

Serie 3000

[Link to Serie 2200](#)



Guide telescopiche ad estrazione totale, per porte sospese da 30 a 120 cm

Totally extractable telescopic guide, for suspended doors from 30 to 120 cm

Porte
Doors





Serie 3100

[Link to Serie 2500](#)



Meccanismo per porte pieghevoli divise in parti uguali

Folding doors equipment divided in two equal parts



Porte
Doors

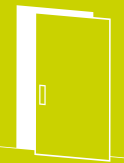

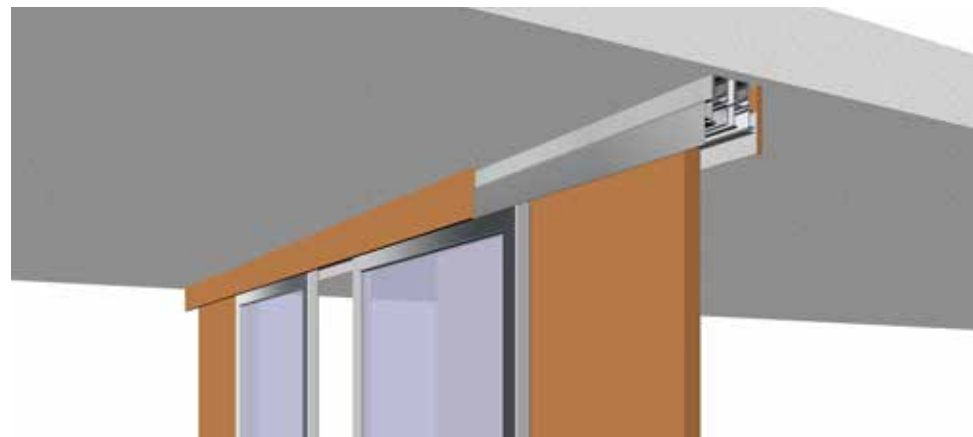

Serie 4800



Link to

Serie 2200 | 5800



Sistema scorrevole regolabile per porte scorrevoli ancorate al soffitto

Adjustable sliding system for sliding doors hanging to the ceiling

Porte
Doors

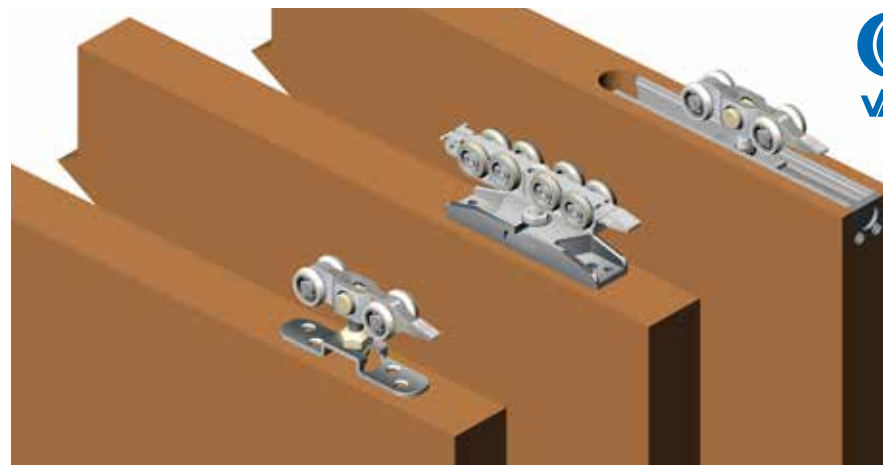

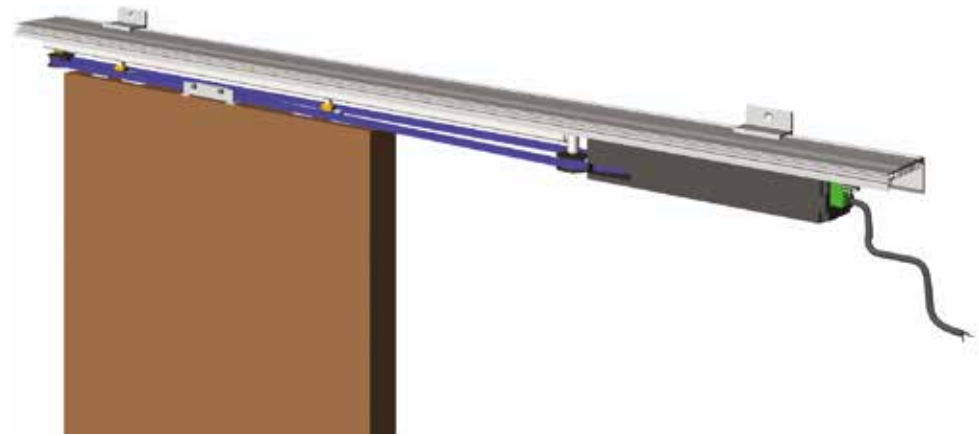

Serie 5000

Link to

Serie 2200 | 5800



Automazione per porte scorrevoli per interni

Automation for interior sliding doors

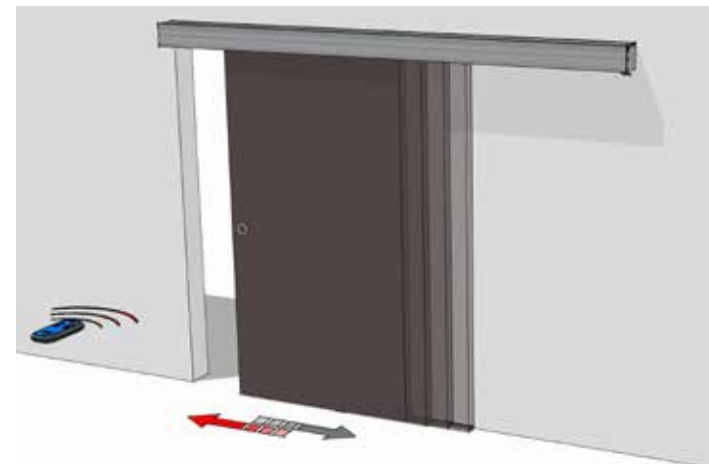

Porte
Doors





Serie 5200

Porte
Doors



Sistema pieghevole per porte divise in parti uguali
con blocco anti-collisione

*Folding system for doors divided in equal parts
with anti-collision device*

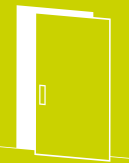

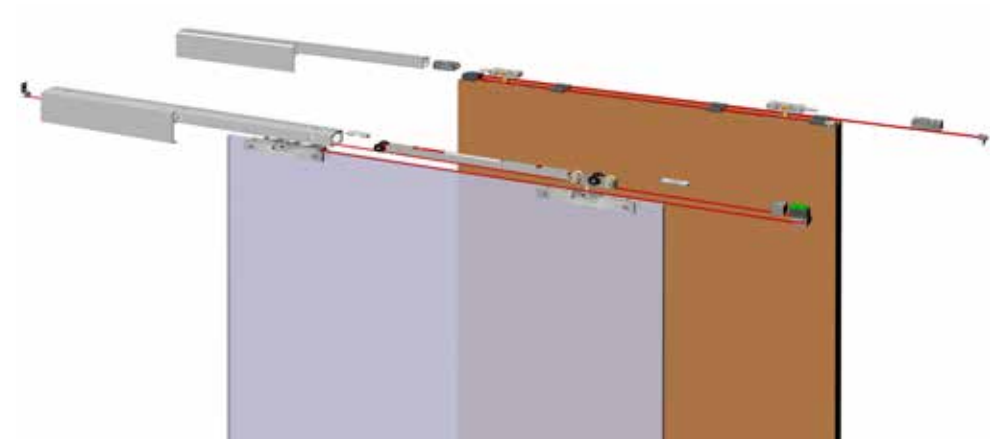

Serie 5500

[Link to Serie 2200 | 5800](#)



Sistema di richiusura automatica per porte scorrevoli interne ed esterne alla parete

Automatic re-closing system for sliding doors inside and outside the wall

Porte
Doors



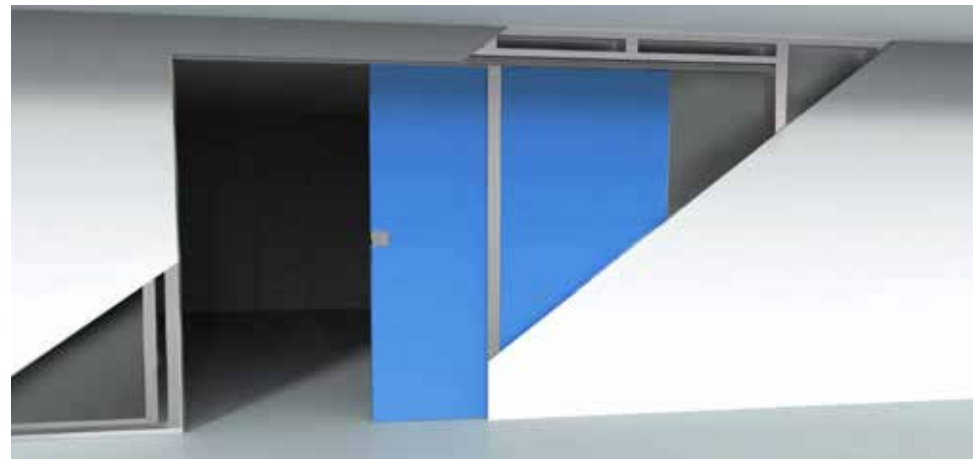

Serie 5600



Link to

Serie 2200 | 5800



Sistema scorrevole a scomparsa per porte fuori misura

Sliding system for pocket doors with out-of-standard size

Porte
Doors



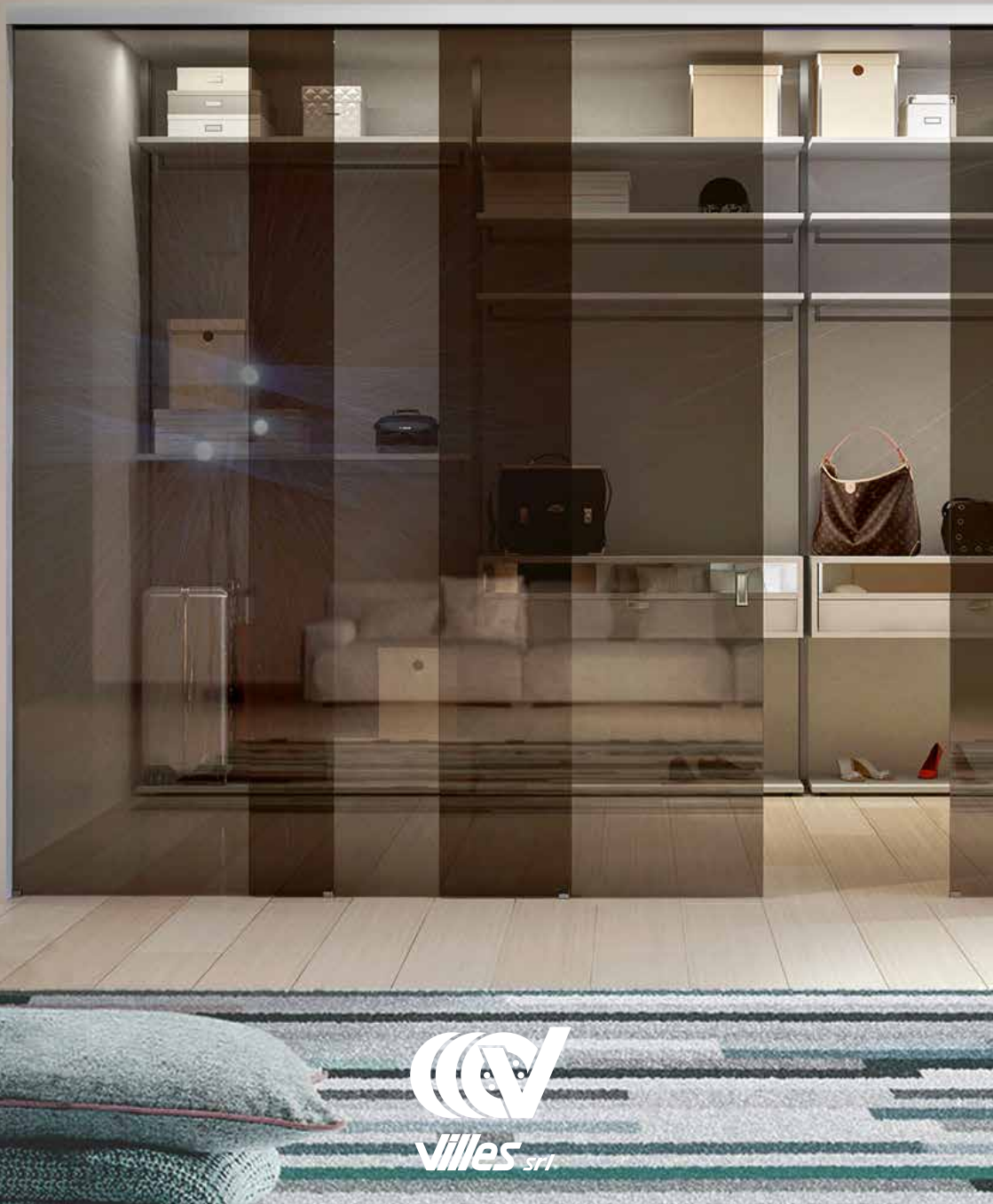

Serie 5700

Link to

Serie 2200 | 5800



Sistema telescopico sincronizzato adatto a 2 porte scorrevoli
più un eventuale pannello fisso

*Synchronized telescopic system suitable for 2 sliding doors
plus a possible fixed panel*

Porte
Doors





Serie 5800

 Link to

Serie 2200 | 2700 | 5000 | 5500



Sistema scorrevole per porte in vetro

Sliding system for glass doors

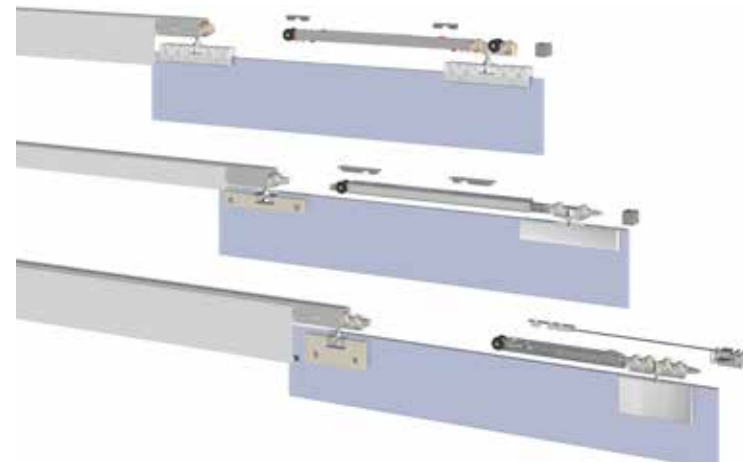

Porte
Doors





Serie 5900

Porte
Doors



Sistema scorrevole per porte di grandi dimensioni fino a 450 Kg

Sliding system for large doors up to 450 Kg

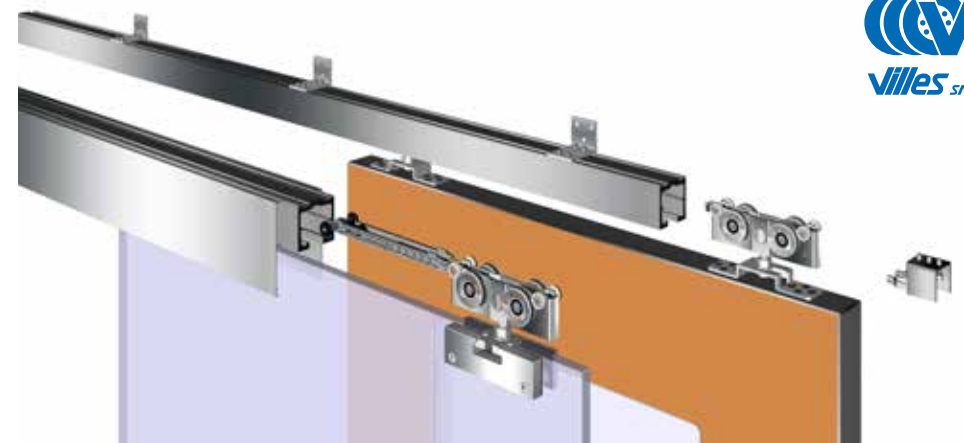
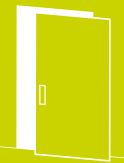



Serie 6200

Porte
Doors



Sistema scorrevole invisibile per porte d'arredo in legno e in vetro

Invisible sliding system for design wooden and glass doors

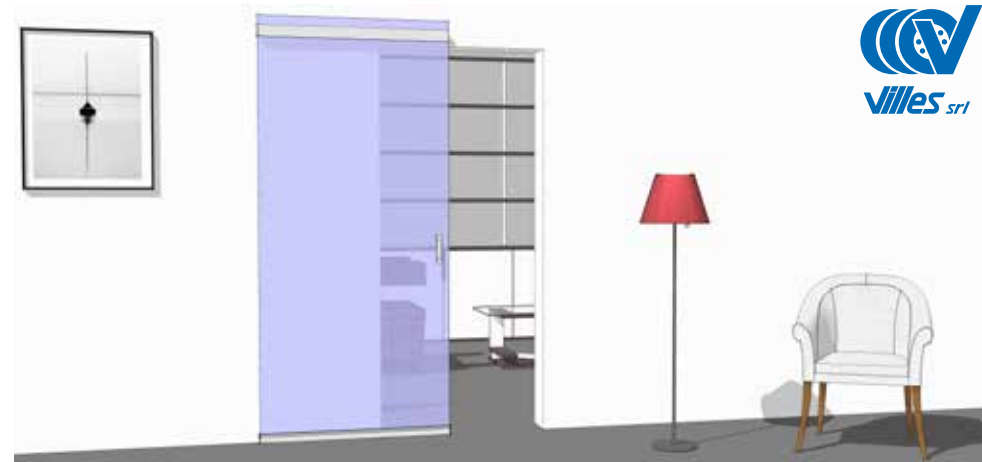



Serie 6400

Porte
Doors



Sistema scorrevole nascosto per porte in vetro

Hidden sliding system for glass doors





Serie 6500

 Link to [Serie 2200](#)



Sistema a bilico e pieghevole per porte di grandi dimensioni,
con apertura ambidestra e bifacciale

*Pivoting and folding system for large doors,
with ambidextrous and double-sided opening*

Porte
Doors

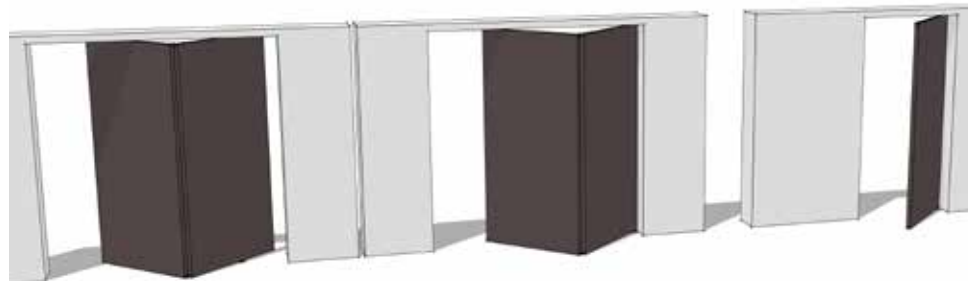

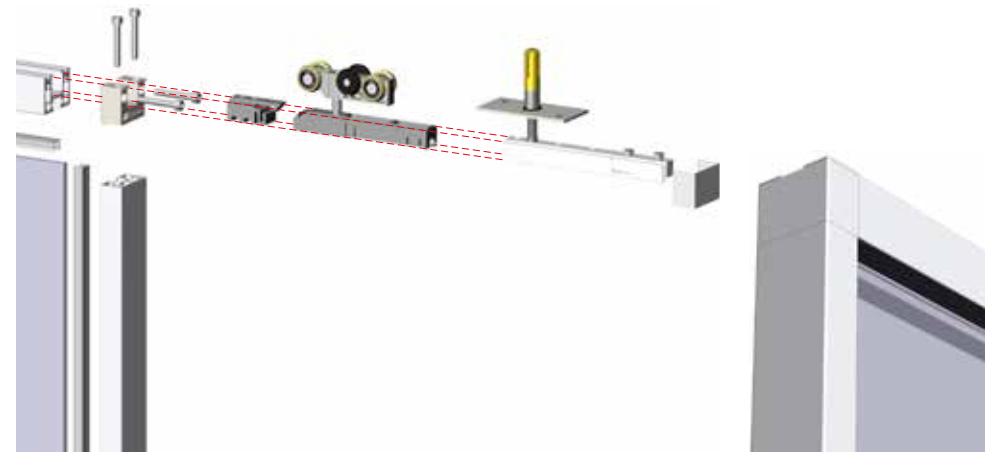
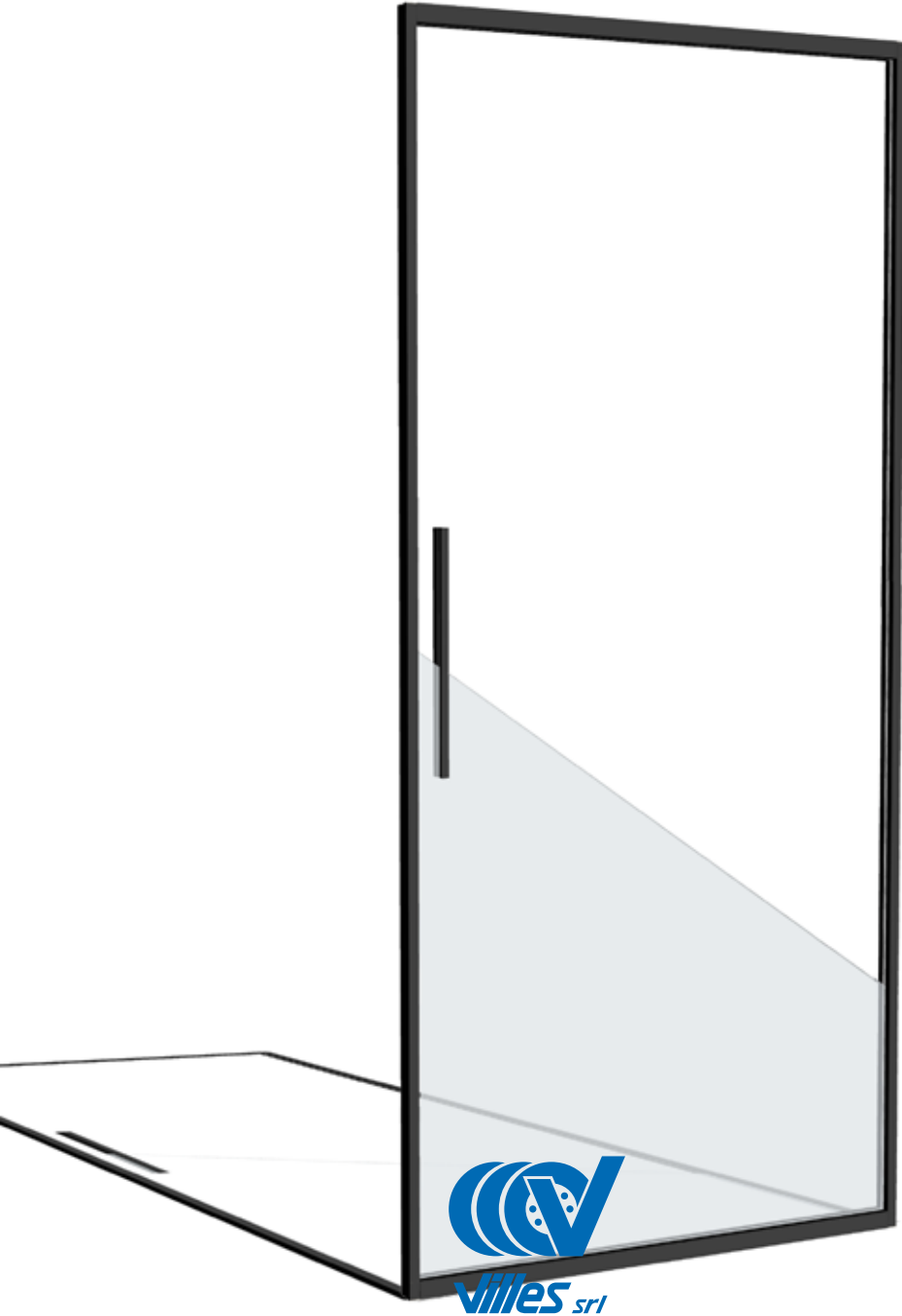

Serie 6700

Porte
Doors



Sistema modulare per anta a telaio in alluminio.
"TAGLIA & UNISCI" e la porta è pronta per ogni modalità di apertura

*Modular system for aluminum frame door.
"CUT & JOIN" and the door is ready for all opening mode*



THE ALL-INCLUSIVE SYSTEM

FOLDING

SLIDING

PIVOT

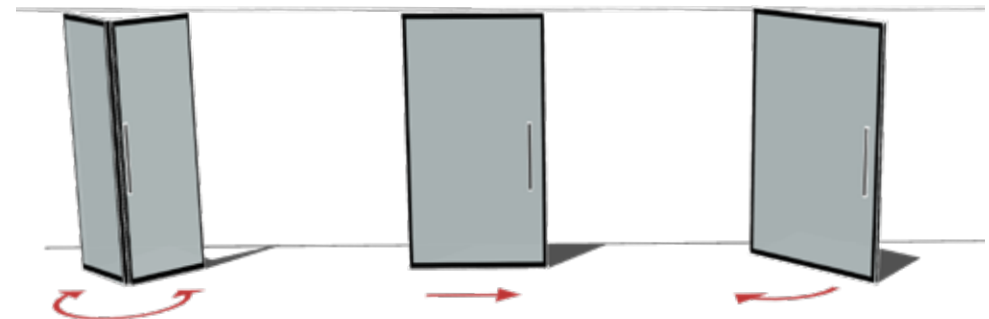

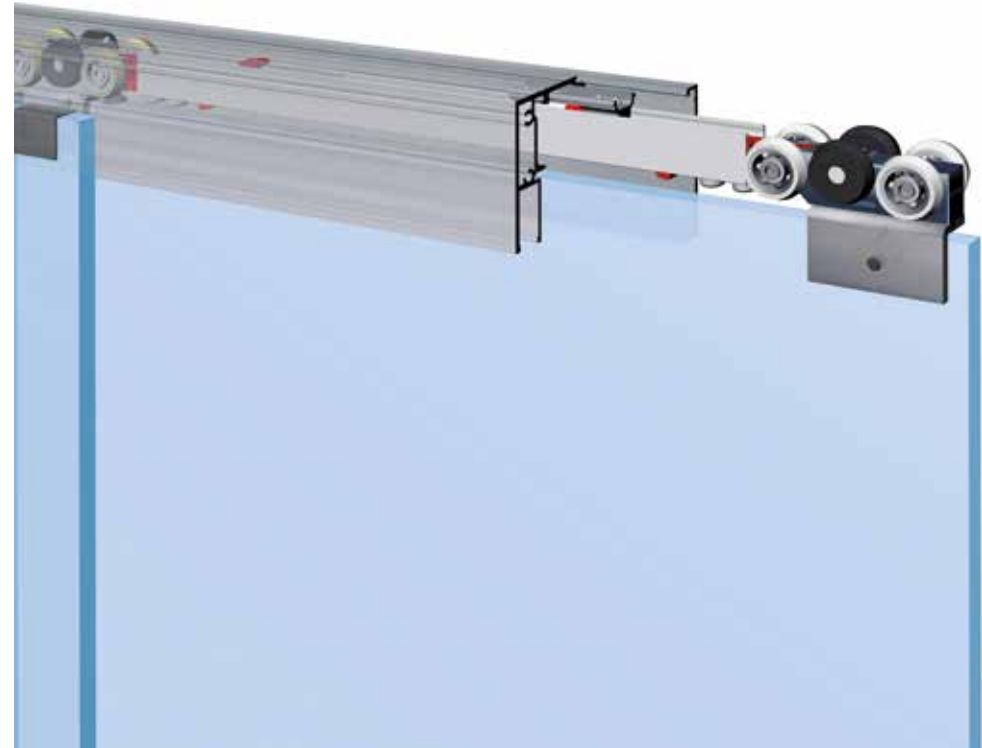

Serie 6000

Box doccia
Shower box



Sistema scorrevole per box doccia
con ammortizzatori di fine corsa

*System for glass sliding shower
rooms with soft close*

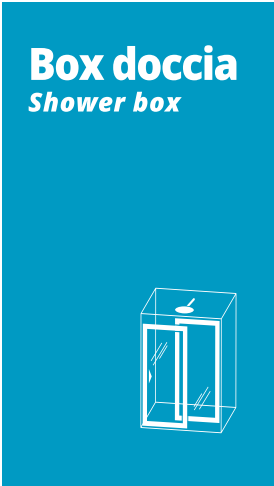

Vuoi il catalogo completo?

Collegandoti al nostro sito web
www.villes2000.com
potrai scaricare tutto quello che necessiti

Se non disponi della password,
richiedila alla nostra email
info@villes2000.com

Do you need the complete catalogue?

*By connecting to our website
www.villes2000.com
you can download everything you need*

*If you don't have the password,
please request it to our email
info@villes2000.com*

Password