

### Kit 5881 | 5881/130

**5881**

Art. List: 5666 x1 | 5669 x1 | M8x35 x2 | 5811 x2 | 5667 x2 | 2467 x2 | 5806 x1 | 2090 x1 | 3308 x1

Icons: 80 Kg, 640, 3000, 1, SOFT, AUTO

**5881/130**

Art. List: 5666 x2 | 5679/S x2 | M8x35 x2 | 5811 x2 | 5667 x2 | 2467 x2 | 5806 x1 | 2090 x1 | 3308 x1

Icons: 130 Kg, 704, 3000, 1, SOFT, AUTO

Avvertenze generali | General warnings

E' molto importante fissare i binari in perfetta posizione orizzontale. It is very important to fix the rails in perfect horizontal position.

Rimuovere detriti e polvere dal binario, se in dotazione tramite la spugna 220. Remove debris and dust from the rail, if available using the sponge 220.

Stringere le viti con moderazione per evitare danneggiamenti. Dopo il posizionamento stringere le viti fino portarle a filo. Tighten the screws with moderation, to avoid breakage. After placement tighten all the screws.

Morsetto G - Art. 5811 | Clamp G - Art. 5811

art. 5811

Vetro senza lavorazione | No drilling glass

Quote di fissaggio | Fixing measures

Guida inferiore 5806 | Lower guide 5806

www.villes2000.com

made in italy

Sul nostro canale i video delle istruzioni di montaggio | Videos of the assembly instructions on our channel

www.youtube.com/Villes2000video

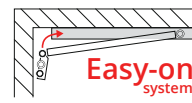

Preparazione binario | Rail preparation

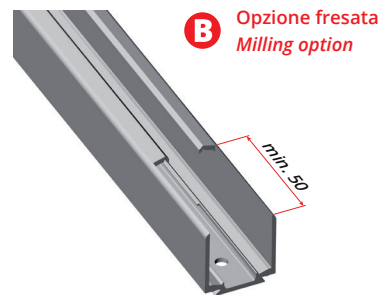
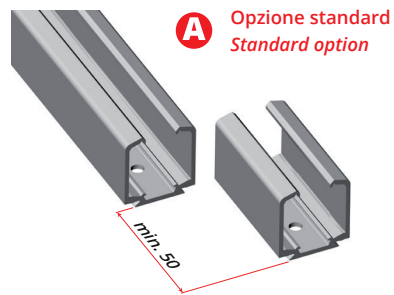
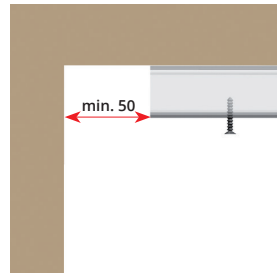

Sequenza di montaggio kit Easy-on | Kit Easy-on assembly sequence

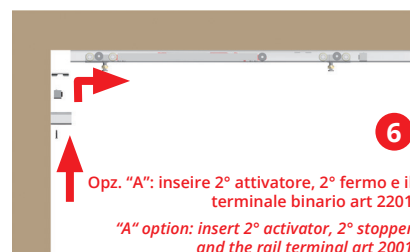
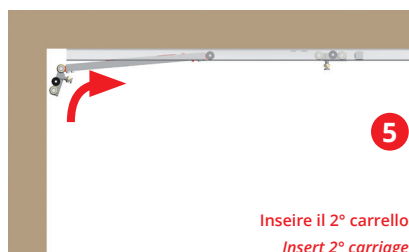
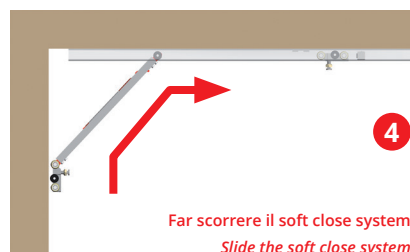
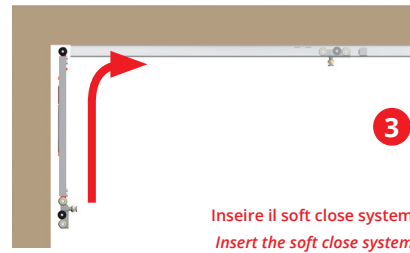
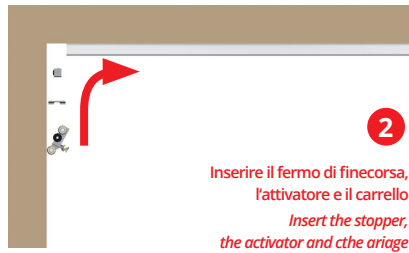
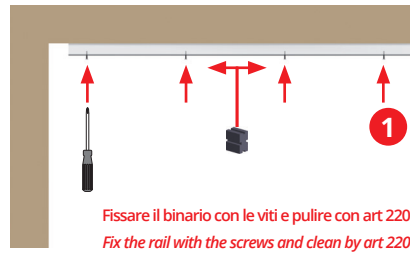

Applicazioni con binario 5801, 5832 e 5833 | Applications with 5801, 5832 and 5833 rail

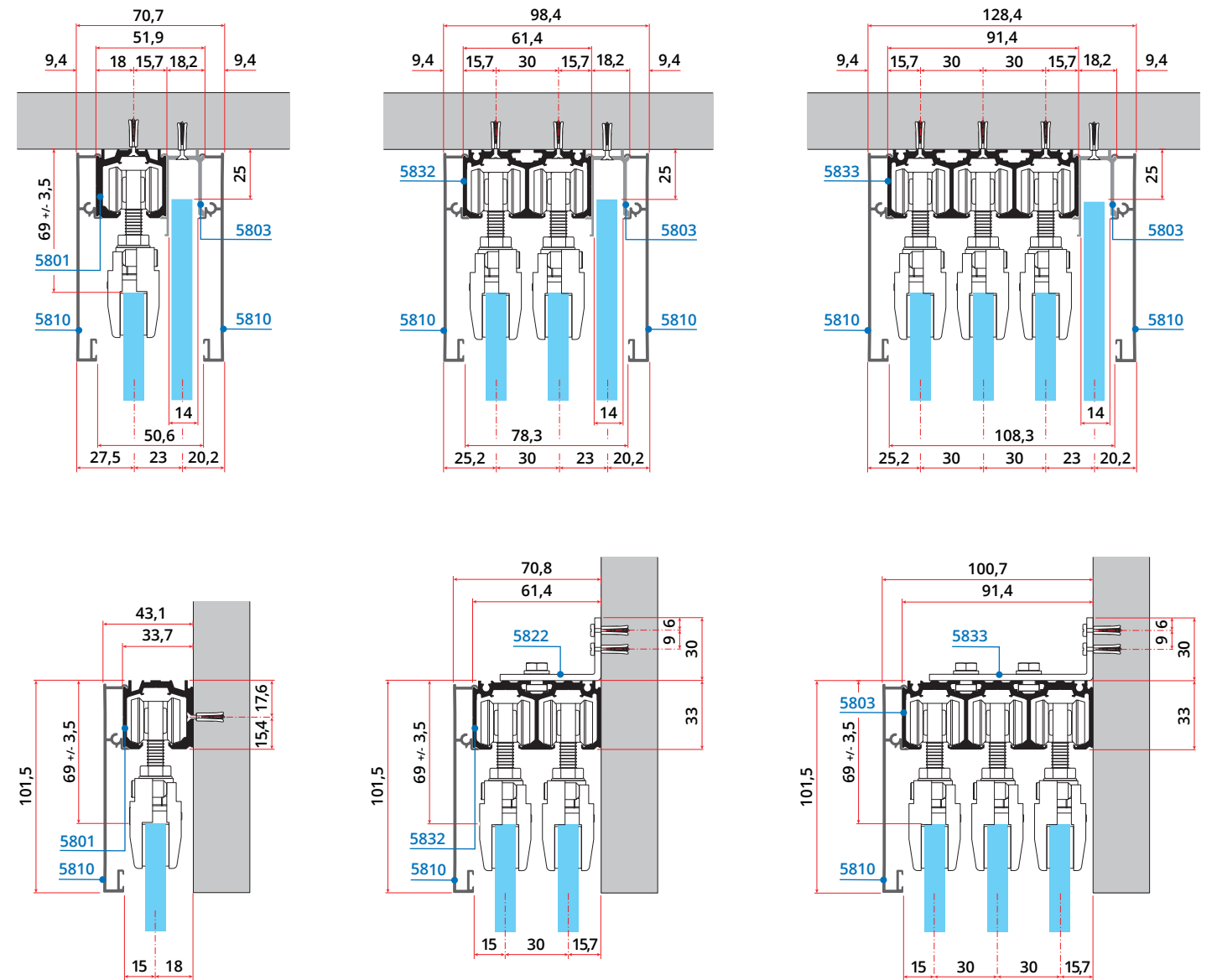
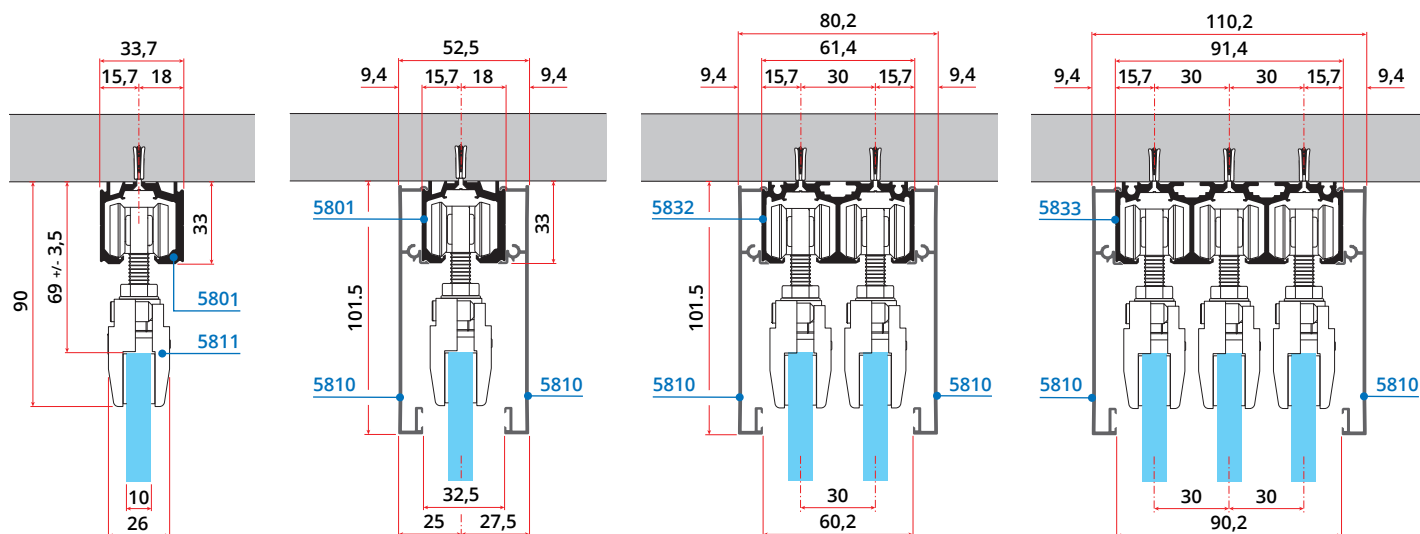

Applicazioni con binario 2201 e 2242 | Applications with 2201 and 2242 rail

