



Serie 1900

**Mobile
Furniture**



Sistema non regolabile per armadi con ante scorrevoli
esteriori sovrapposte

*Not adjustable system for wardrobes with overlapping external
sliding doors*

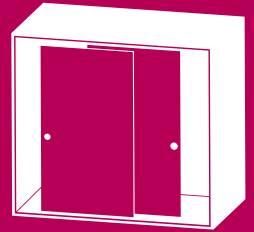

Informazioni tecniche | Technical informations

Versioni per 2 diversi spessori di anta (25 e 30 mm)
 Versions for 2 different door thicknesses (25 and 30 mm)

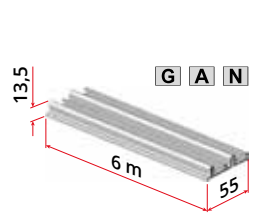

Art. 2001
 Binario superiore in alluminio
 Aluminium upper rail

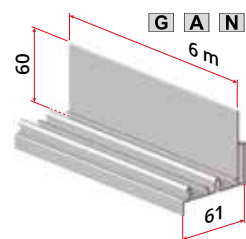

art. 4401
 Profilo superiore in alluminio forato, rinforzato
 Upper aluminium profile pierced strengthened

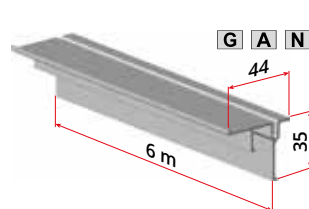

Art. 2002
 Binario inferiore in alluminio
 Aluminium lower rail

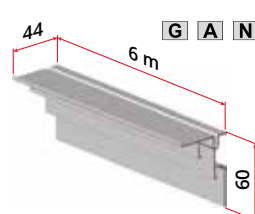

art. 2062
 Profilo inferiore in alluminio con zoccolo H 60 mm
 Aluminium lower profile with wainscot H 60 mm

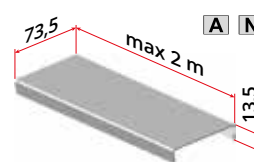

Art. 2009
 Rivestimento a scatto in metallo per anta esterna
 Clicking metal cover for external door

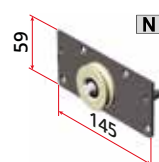

Art. 1903/N
 Carrello superiore ambidestro per anta interna
 Ambidextrous upper carriage internal door

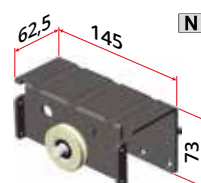

Art. 1905/25/N
 Carrello superiore ambidestro per anta esterna spessore 25 mm
 Upper carriage for external door thickness 25 mm

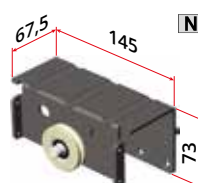

Art. 1905/30/N
 Carrello superiore ambidestro per anta esterna spessore 30 mm
 Upper carriage for external door thickness 30 mm

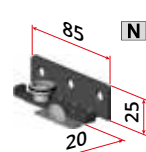

Art. 2004/SX/N
 Guida inferiore sinistra per anta interna
 Left lower guide for internal door

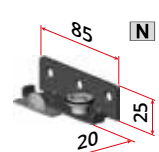

Art. 2004/DX/N
 Guida inferiore destra per anta interna
 Right lower guide for internal door

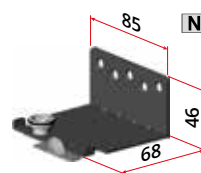

Art. 2006/25/SX/N
 Guida inferiore sinistra per anta esterna spessore 25 mm
 Left lower guide for external door thickness 25 mm

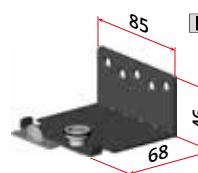

Art. 2006/25/DX/N
 Guida inferiore destra per anta esterna spessore 25 mm
 Right lower guide for external door thickness 25 mm

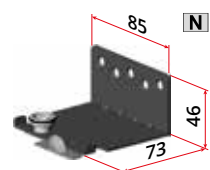

Art. 2006/30/SX/N
 Guida inferiore sinistra per anta esterna spessore 30 mm
 Left lower guide for external door thickness 30 mm

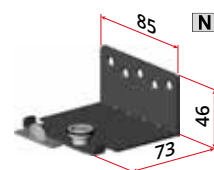

Art. 2006/30/DX/N
 Guida inferiore destra per anta esterna spessore 30 mm
 Right lower guide for external door thickness 30 mm

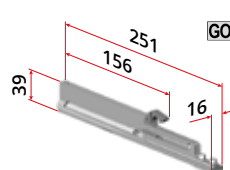

art. 5357
 Fermo superiore ammortizzato, corsa 55 mm, funzionamento ad olio silconico
 Upper soft close, 55 mm stroke, operating with silicone oil

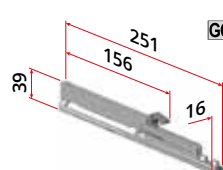

art. 5357/S
 Fermo superiore ammortizzato, corsa 55 mm, funzionamento ad olio silconico, versione premium
 Upper soft close, 55 mm stroke, operating with silicone oil, premium version

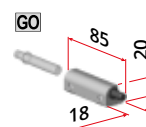

Art. 4448
 Fermo inferiore ammortizzato ambidestro
 Lower ambidextrous soft close

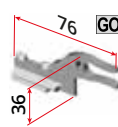

Art. 2007
 Fermo superiore in nylon
 Nylon upper stopper

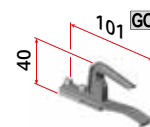

Art. 4407
 Fermo superiore in nylon
 Nylon upper stopper

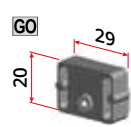

Art. 2008
 Fermo inferiore in nylon
 Nylon lower stopper

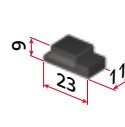

art. 2010
 per/for art. 2204 - 2206
 Antiscarrucolamento supplementare
 Additional anti-fleeting device



Art. 2090
 Chiave a brugola mm 3
 Allen key mm 3

Spessore anta 25 mm | Door thickness 25 mm

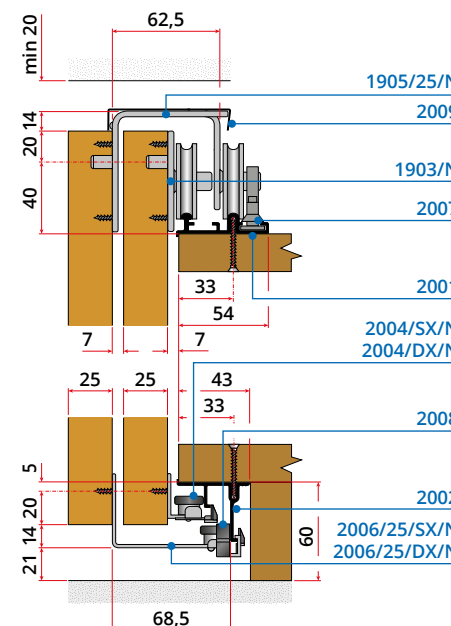

Alternativa al 2001
 Alternative to 2001

Alternativa al 2002
 Alternative to 2002

Kit compatibili
 Matching kits
 1903-4
 1905-6/25

Spessore anta 30 mm | Door thickness 30 mm

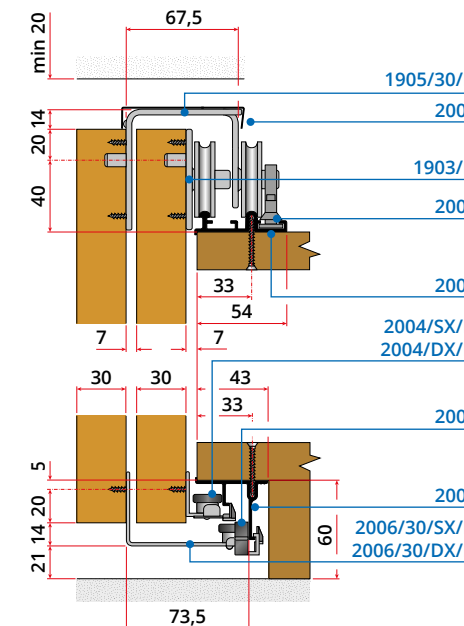

Kit compatibili
 Matching kits
 1903-4
 1905-6/30

Foratura anta interna ed esterna (fianco del mobile 25 mm) Internal and external door drilling (furniture side panel 25 mm)

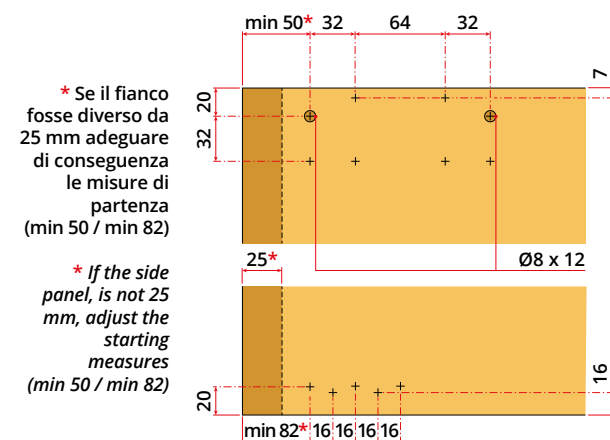

* Se il fianco fosse diverso da 25 mm adeguare di conseguenza le misure di partenza (min 50 / min 82)

* If the side panel, is not 25 mm, adjust the starting measures (min 50 / min 82)

Fermo superiore in nylon Upper nylon stopper

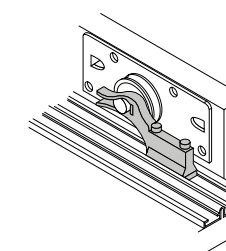

Art. 2007
 Fermo superiore in nylon
 Upper nylon stopper

In alternativa utilizzare art. 4407
 Alternatively use the stopper art. 4407

Fermo inferiore in nylon Lower nylon stopper

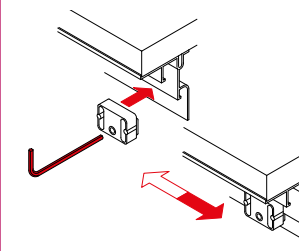

Art. 2008
 Fermo inferiore da fissare al binario, inseribile e regolabile frontalmente.

Lower stopper to be fixed to the track, insertable, adjustable from the front.

Istruzioni montaggio | Assembly instructions

Montaggio ante interne ed esterne | Assembly of internal and external doors

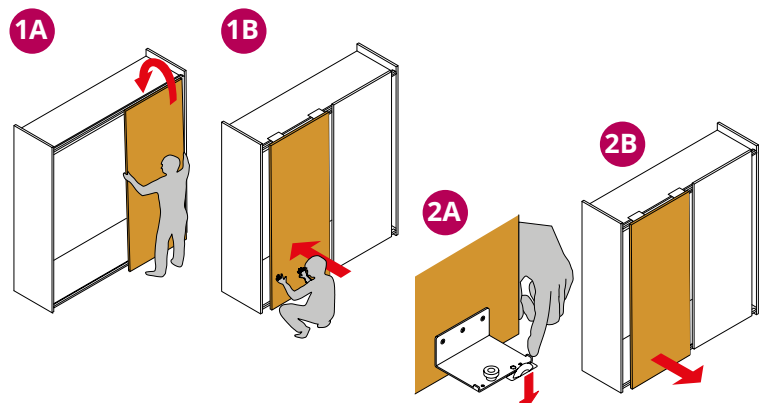

Montaggio ante interne ed esterne

1A Con l'anta inclinata appoggiare le ruote dei carrelli superiori nella sede del binario.

1B Premere alla base dell'anta per consentire l'inserimento a scatto della guida inferiore nel binario.

Rimozione ante interne ed esterne

2A Per lo smontaggio dell'anta agire sul meccanismo a scatto della guida inferiore, premendo le due molle.

2B Estrarre l'anta tirando verso l'esterno.

Assembly of internal and external doors

1A With the door tilted, place the wheels of the upper carriages in the track seat.

1B Press the base of the door to allow the lower guide to be clicked.

Removal of internal and external doors

2A To disassemble the door, act on the click mechanism of the lower guide, pressing the two springs.

2B Remove the door pulling outwards.

Varianti e optional | Variants and optionals

Montaggio fermi soft close Kit art. 4478 | Soft close stoppers Kit art. 4478 assembling

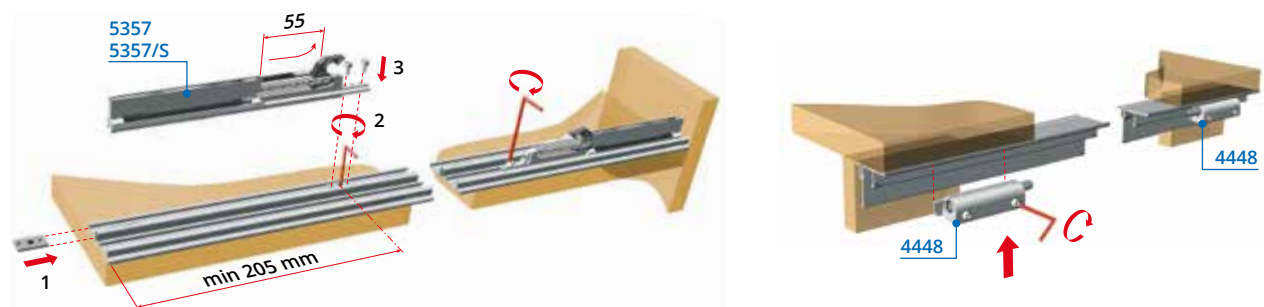

Foratura per fermi soft close (art. 4478) Drilling for soft close stoppers (art. 4478)

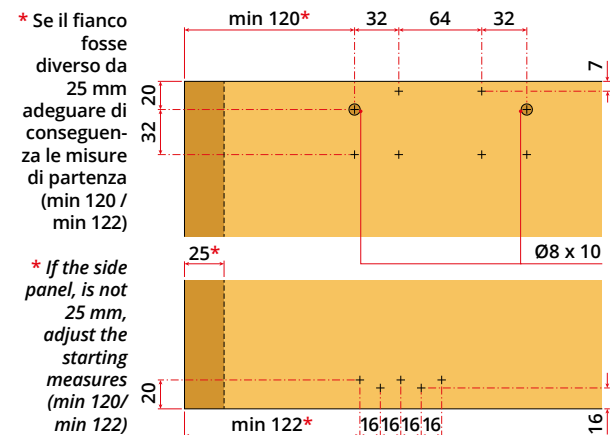

Altri tipi di fermi | Optional stoppers

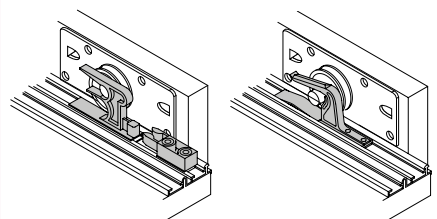

Art. 2017
Fermo superiore invisibile composto da due parti divise con funzione anticarrucolamento
Invisible upper stopper composed of two divided parts with antifleeting mode.

Art. 4407
Fermo superiore in nylon dotato di richiamo di fine corsa
Upper nylon stopper with end stop recall

Antiscarrucolamento supplementare Additional anti-fleeting device

Art. 2010
Da fissare prima di agganciare l'anta al mobile.
Fix before attaching the door to the cabinet

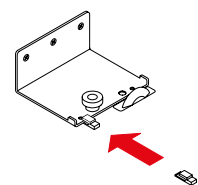

Lista Kit e profili principali | Kits list and main profiles



Kit	Art. List	Weight (Kg)	Dimensions (mm)	Soft Close	Auto Close
1903-4/N	1903/N x2 2004/SX/N x1 2004/DX/N x1 2007 x2 2008 x2 2090 x1	65	600 / 1800	1	SOFT / AUTO
1905-6/25/N	1905/25/N x2 2006/25/SX/N x1 2006/25/DX/N x1 2007 x2 2008 x2 2090 x1	65	600 / 1800	1	SOFT / AUTO
1905-6/30/N	1905/30/N x2 2006/30/SX/N x1 2006/30/DX/N x1 2007 x2 2008 x2 2090 x1	65	600 / 1800	1	SOFT / AUTO
4478	Art. List: 5357 x2 4448 x2	65	800 / 2000	1	SOFT / AUTO
4478/S	Art. List: 5357/S x2 4448 x2	65	800 / 2000	1	SOFT / AUTO