



2.0

Serie 5100

Link to

Serie 2000 | 5300



Sistema di chiusura automatica e rallentata
per mobili con ante scorrevoli

*Automatic and slowed closing system
for furniture with sliding doors*

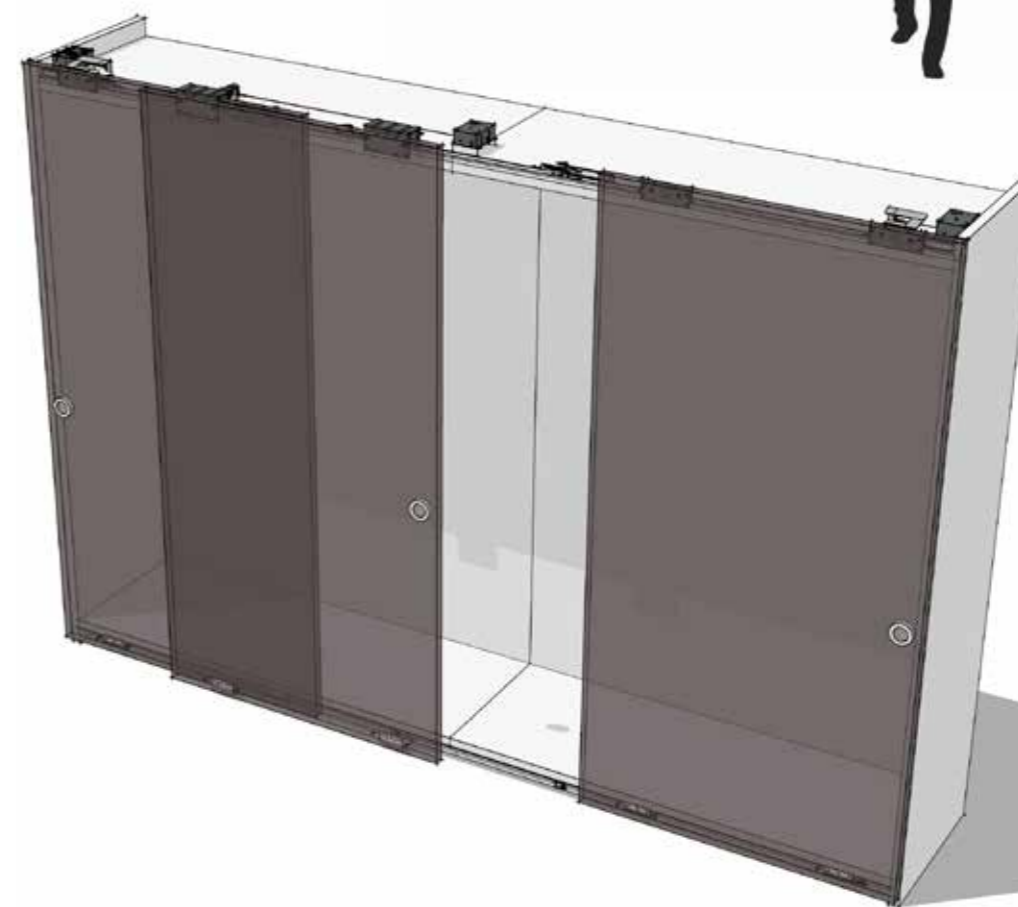

**Mobile
Furniture**

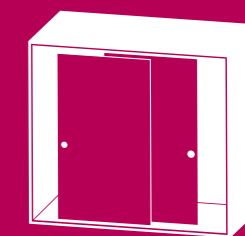

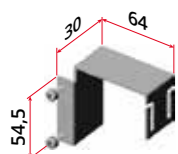

Art. 5103
per/for art. 2005/SX - 2005/DX
Staffa di aggancio del cavo di trascinamento per il carrello dell'anta esterna per serie 2000
Carriage dragging cable hooking bracket of the external door for serie 2000

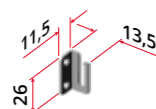

Art. 5105
Staffa di aggancio del cavo di trascinamento, per applicazioni universali dell'art. 5101
Bracket for coupling the dragging cable, for universal applications of art. 5101

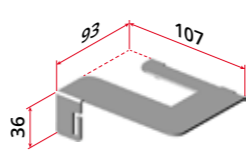

Art. 5106/SX
per/for art. 2003/SX
Staffa di aggancio del cavo di trascinamento per il carrello dell'anta interna sinistra per serie 2000
Carriage dragging cable hooking bracket of the left internal door for serie 2000

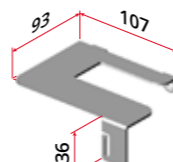

Art. 5106/DX
per/for art. 2003/SX
Staffa di aggancio del cavo di trascinamento per il carrello dell'anta interna destra per serie 2000
Carriage dragging cable hooking bracket of the right internal door for serie 2000

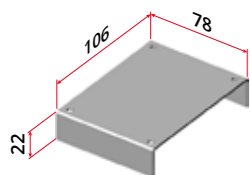

Art. 5109
per/for art. 5001
Staffa di supporto per il fissaggio dell'art. 5101 sulla parte superiore del mobile, per serie 2000
Support bracket for fixing art. 5101 on the furniture top, for serie 2000

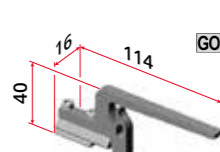

Art. 5307
Fine corsa superiore senza trattenimento per serie 2000 e 5300
Upper end-run without holding for series 2000 and 5300

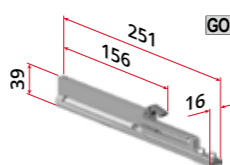

Art. 5357
Fermo superiore SX / DX ammortizzato, corsa 55 mm, funzionamento ad olio silconico. Per serie 2000 e 5300
Upper stop shock-absorbed L / R, 55 mm stroke. Working with silicone oil. For series 2000 and 5300

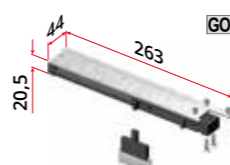

Art. 5373
per/for art. 5303 - 5305
Fermo superiore ammortizzato ad aria, corsa 70 mm. Per serie 5300
Upper stop shock-absorbed, 70 mm stroke, working with air For series 5300

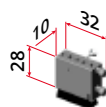

art. 5333
per/for art. 5303-5305
Accessorio di aggancio con spazzola pulisci binario per serie 5300
Hooking accessory with rail brush cleaning for serie 5300

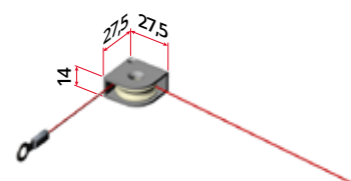

Art. 5115
Ruota di rinvio per applicazioni universali dell'art. 5101
Return wheel for universal applications of art. 5101

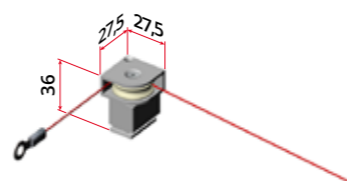

Art. 5151
per/for art. 5301
Ruota di rinvio da fissare al binario 5301 adatto alle ante interne ed esterne, per Serie 5300
Return wheel to be fixed to the rail art. 5301 and suitable for internal and external doors. For serie 5300

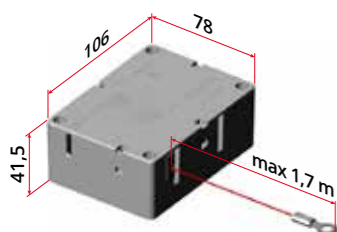

Art. 5101/40
Meccanismo di richiusura a molla con ammortizzatore per ante fino a 40 Kg
Corsa massima 170 cm
Reclosing spring system with shock-absorber suitable for door with capacity up to 40 Kg. Maximum stroke 170 cm

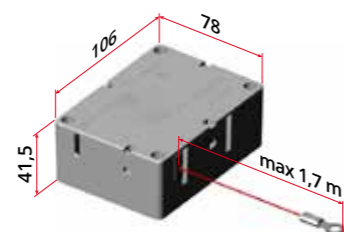

Art. 5101/60
Meccanismo di richiusura a molla con ammortizzatore per ante fino a 60 Kg
Corsa massima 170 cm
Reclosing spring system with shock-absorber suitable for door with capacity up to 60 Kg. Maximum stroke 170 cm

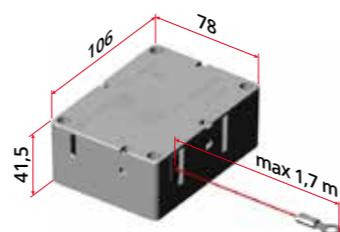

Art. 5101/80
Meccanismo di richiusura a molla con ammortizzatore per ante fino a 80 Kg
Corsa massima 170 cm
Reclosing spring system with shock-absorber suitable for door with capacity up to 80 Kg. Maximum stroke 170 cm

Informazioni tecniche | Technical informations

Specifiche art. 5101/40 - 5101/60 - 5101/80 | Specifications art. 5101/40 - 5101/60 - 5101/80

Sistema di chiusura automatica a velocità controllata dal rallentatore, che agisce su tutta la corsa dell'anta, garantendo la richiusura automatica fino a oltre 1,7 metri di corsa, a fronte di un leggero e costante carico in apertura.

La sua compatta forma, la possibilità di essere capovolto e le 3 diverse uscite (1,2,3) della fune facilitano il fissaggio e garantiscono il corretto posizionamento per ogni utilizzo. Viene fornito con fune in posizione 2.

Speed-controlled automatic closing system. The retarder, which acts on the entire stroke of the door, guarantees automatic re-closing up to over 1.7 meters of stroke, against a light and constant load on opening.

Its compact shape, the possibility of being turned upside down and the 3 different output (1,2,3) of the rope facilitate fastening and ensure the correct positioning for each use. It is supplied with rope in position 2.

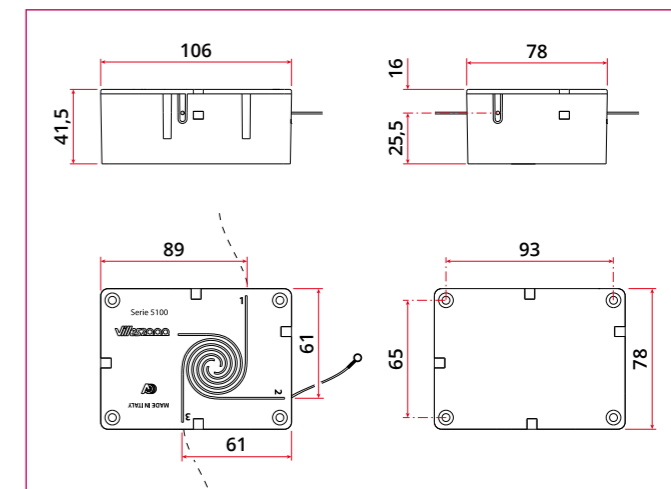
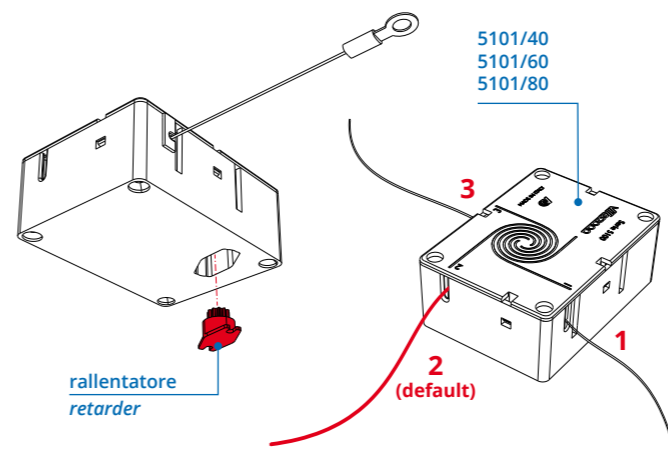

Accessori per l'impiego della Serie 5100 in modo universale Accessories for the universal application of Serie 5100

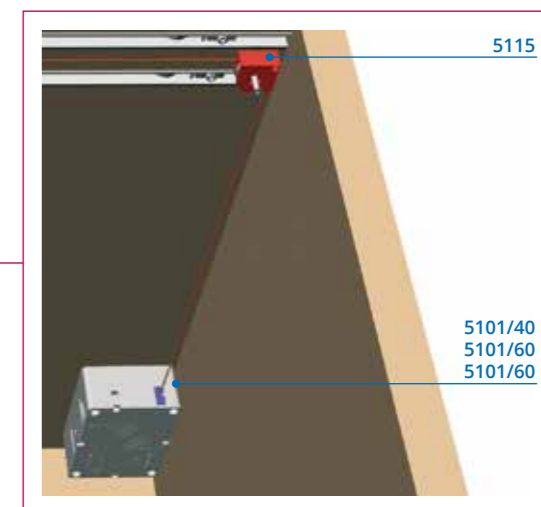
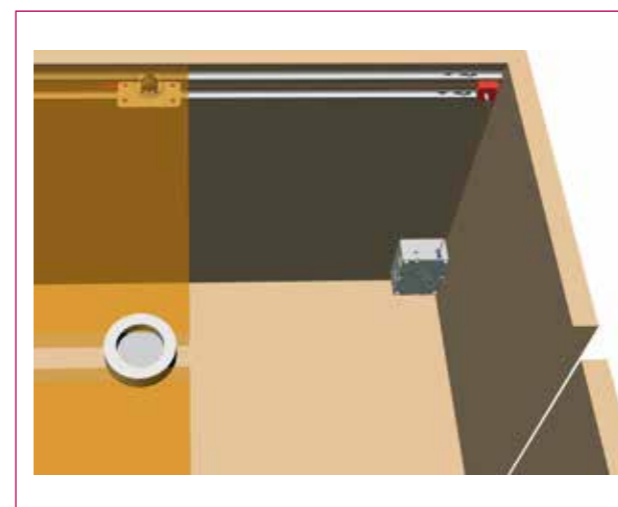
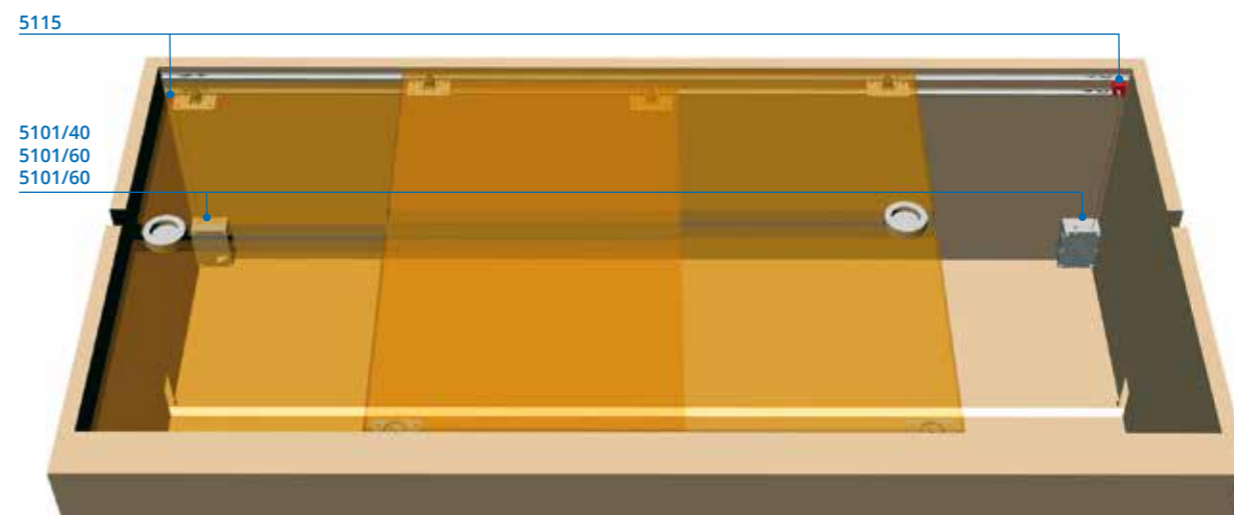

Impostazione dell'uscita della fune, posizioni 1-2-3 | Rope output setting, position 1-2-3

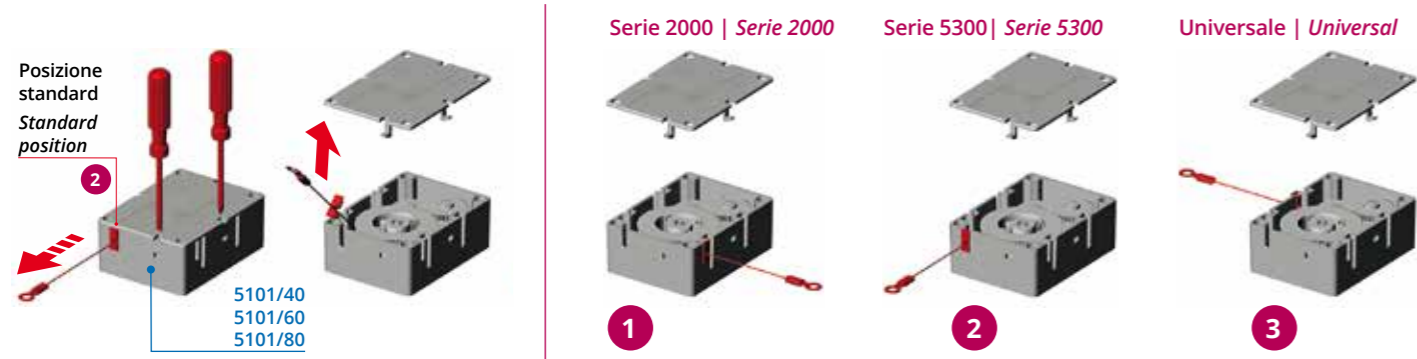

Accessori per l'impiego della Serie 5100 abbinati alla Serie 2000
Accessories for the Serie 5100 combined to Serie 2000



Combinazioni per anta esterna | External door combinations

Kit compatibili Matching kits	Kit compatibili Matching kits
5125	2053-6/25/Z - 2053-8/25/Z 2053-6/30/Z - 2053-8/30/Z 2053-6/33/Z - 2053-8/33/Z

Combinazioni per anta interna | Internal door combinations

Kit compatibili Matching kits	Kit compatibili Matching kits
5123/SX 5123/DX	2053-4

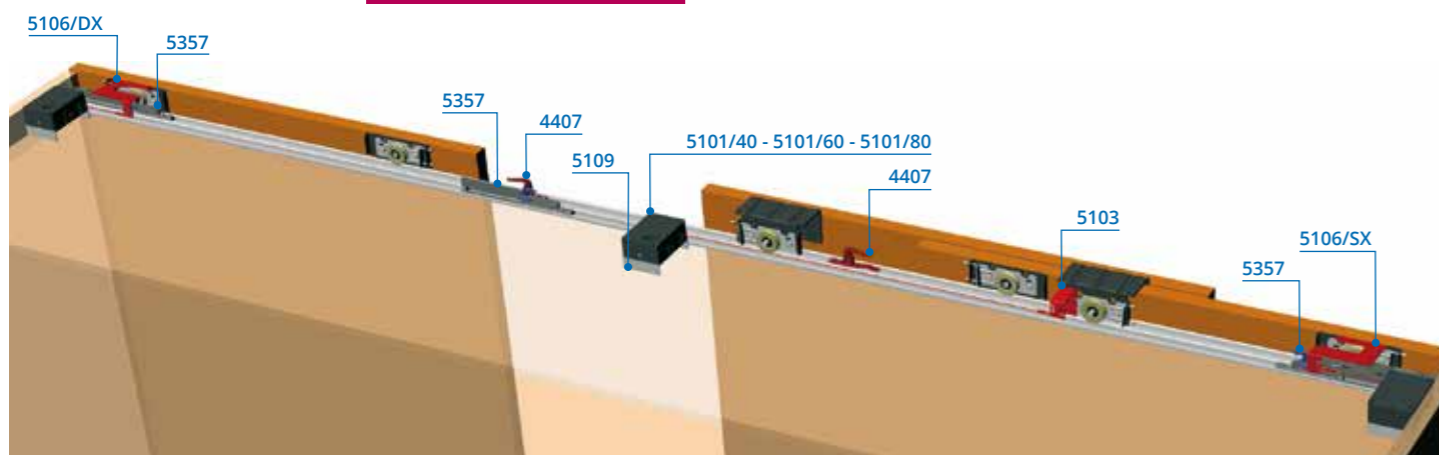

Istruzioni montaggio | Assembly instructions

Applicazione su ante interne | Application on internal doors

A

Impostare l'uscita della fune in posizione 1
Per il fissaggio utilizzare 4 viti Ø 4 x 80 mm
Set the output of the rope in position 1
Use 4 screws Ø 4 x 80 mm for fixing

B

Fissare gli articoli 5106/SX e 5106/DX
Fix the articles 5106/SX and 5106/DX

C

Collegare la fune all'art. 5106/DX
Connect the rope to art. 5106/DX

Applicazione su ante esterne | Application on external doors

A

Impostare l'uscita della fune in posizione 1
Per il fissaggio utilizzare 4 viti Ø 4 x 80 mm
Set the output of the rope in position 1
Use 4 screws Ø 4 x 80 mm for fixing

B

Fissare l'articolo 5103
Fix the article 5103

C

Collegare la fune all'art. 5103
Connect the rope to art. 5103

Lavorazione ante | Door working

Per la foratura delle ante fare riferimento allo schema contenuto nella Serie 2000 MIX di questo catalogo, sezione soft close
Regarding the door drilling, refer to the scheme of the soft close section, included in the Serie 2000 MIX of this catalogue.

Lista Kit e profili principali | Kits list and main profiles

Art. 2001	Art. 2052
5123/SX	5123/DX
Art. List: 5307 x1 5357 x1 5106/SX x1 5109 x1 5101/60 x1	Art. List: 5307 x1 5357 x1 5106/DX x1 5109 x1 5101/60 x1
5125	
Art. List: 5307 x1 5357 x1 5103 x1 5109 x1 5101/60 x1	



Accessori per l'impiego della Serie 5100 abbinati alla Serie 5300
Accessories for the Serie 5100 combined to Serie 5300



Combinazioni per anta esterna | External door combinations

Kit compatibili Matching kits	Kit compatibili Matching kits
5130	5360 5360/35 5360/M 5360/M/35

Combinazioni per anta interna | Internal door combinations

Kit compatibili Matching kits	Kit compatibili Matching kits
5130	5350 5350/35 5350/M 5350/M/35

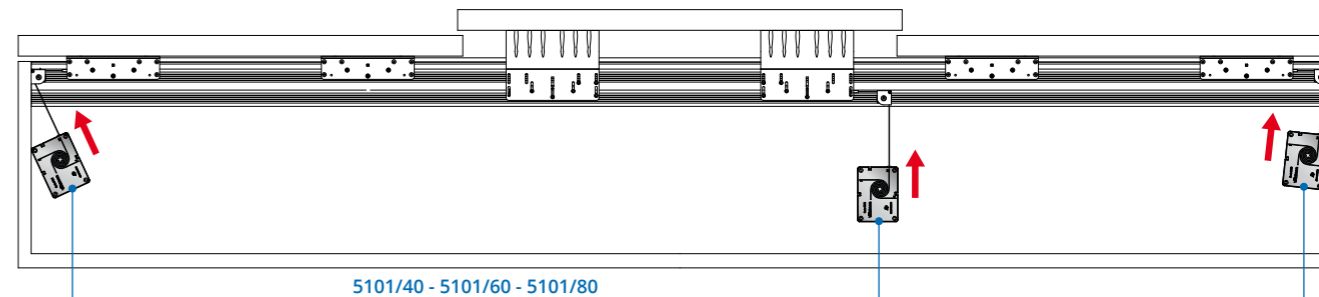
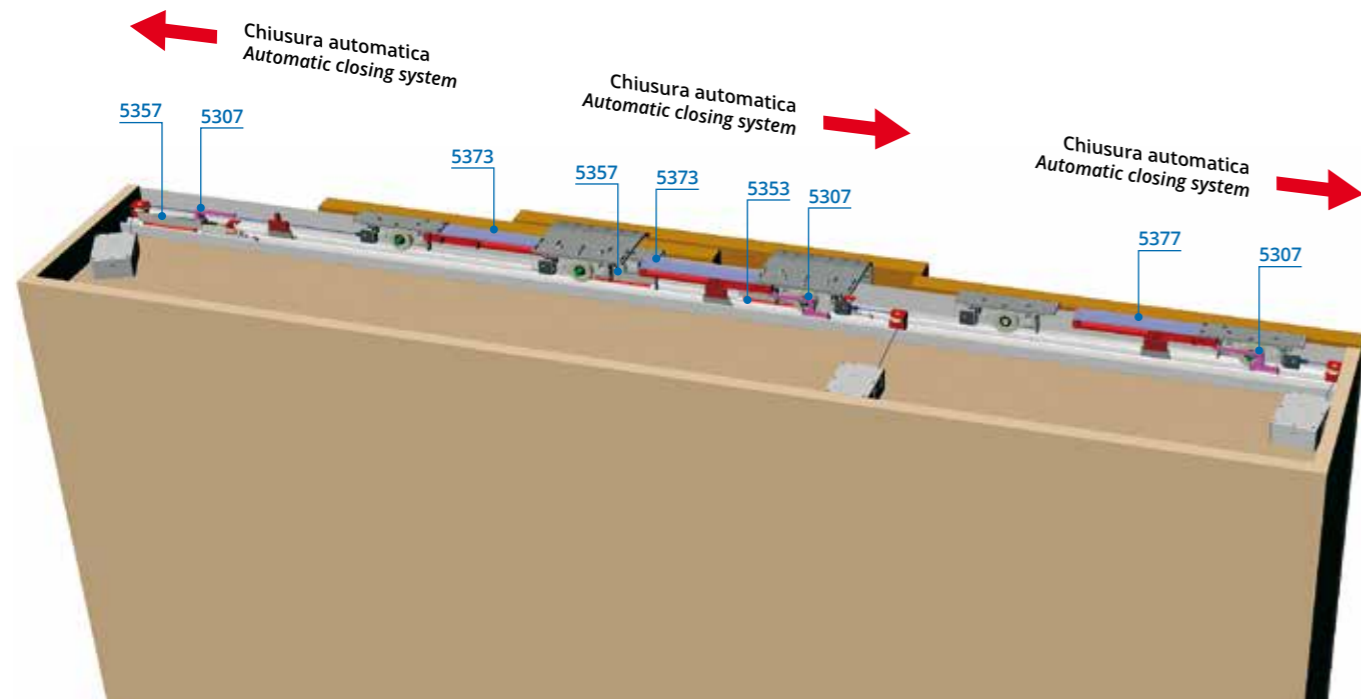

Nota | Note

Posizionare i richiusori art. 5101/40 - 5101/60 - 5101/80 sulla parte superiore del mobile evitando che la fune strisci sul bordo della scatola o interferisca con altri componenti.
Put the reclosers art. 5101/40 - 5101/60 - 5101/80 on the upper part of the furniture avoiding the scratching of the rope on the edge of the box or interferes with other components.

Inserimento del cavo all'interno della carrucola (art. 5153) e fissaggio al gancio (art. 5333)
Cable inserting inside the pulley (art. 5153) and hooking (art. 5333)

A

Inserire la fune all'interno della puleggia (art. 5153), rimuovendo la vite.
Insert the rope inside the pulley (art. 5153), removing the screw.

B

Posizionare la puleggia (art. 5153) all'interno del binario (art. 5301) stringendo la vite.
Place the pulley (art. 5153) inside the rail (art. 5301) by tightening the screw.

C

Inserire il capo della fune all'interno dell'art. 5333 stringendo l'apposita vite.
Insert the end of the rope inside art. 5333 tightening the appropriate screw.

D

Fissare l'art. 5333 al carrello in utilizzo.
Fix the art. 5333 to the carriage in use.

Istruzioni montaggio | Assembly instructions

Applicazione su ante interne ed esterne | Application on internal and external doors

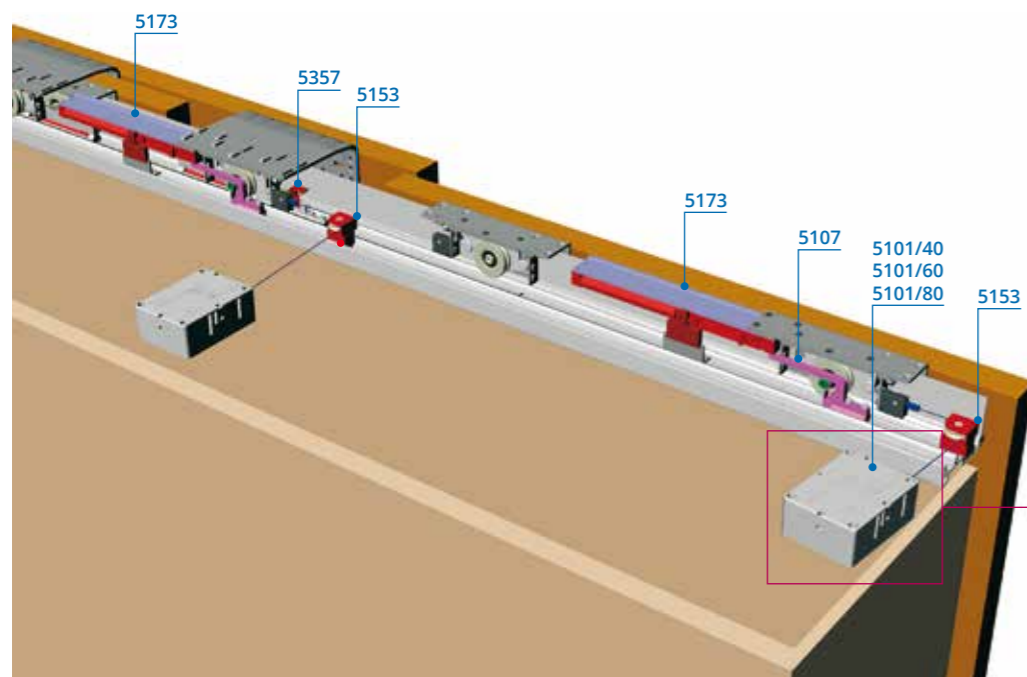

A
Impostare l'uscita della fune in posizione standard ②
Set the rope output in the standard position ②

B
Fissare la scatola sul top del mobile utilizzando 4 viti Ø 4 x 60 mm
Fix the box on the furniture top using 4 screws Ø 4 x 60 mm

Lista Kit e profili principali | Kits list and main profiles

Art. 5301	Art. 5311	Art. 5302
5130	Per anta sinistra e destra For left and right door	
Art. List: 5307 x1 5373 x1 5333 x1 5153 x1 5101/80 x1		